

# PRODUCT SHEETS

# SMART-PAX QC

Art. No. 3341



SMARTPAX QC is the key building block in the Dataton multimedia control system. It is used to control CD players, laserdiscs, slide projectors, infrared or MIDI controlled devices, lighting, power relays, computer

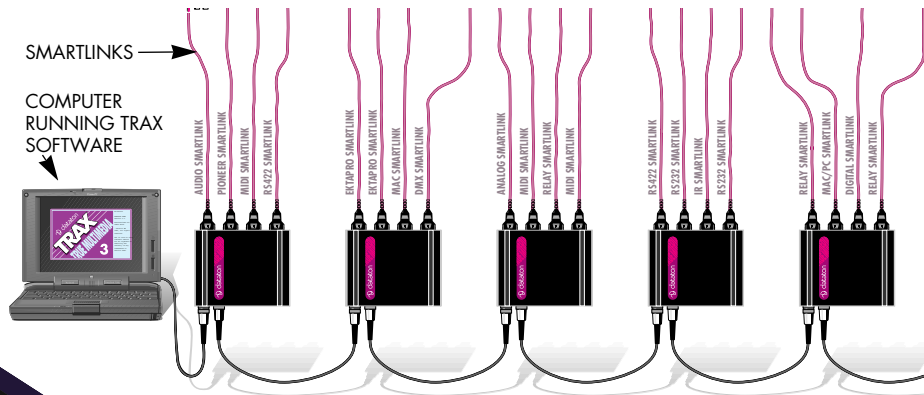

presentation programs and more.

SMARTPAX QC interprets the signals sent from Dataton TRAX® programming software running on a MacOS type of computer and converts them into the individual languages used by the various devices. Software device drivers loaded into the SMARTPAX QC handle the syntax of each device's language. Smartlink

cables then connect the SMARTPAX QC to the devices, ensuring that the proper kind of signal reaches the device. One SMARTPAX QC may control four different devices. In situations where more devices have to be controlled, several SMARTPAX QC units may be daisy-chained to achieve the required number of control channels, as shown above.

# FUNCTIONAL DESCRIPTION

## FRONT PANEL



**IN** Connects SMARTPAX QC to a previous control unit in a chain of multiple Dataton units (with SYSTEM CABLE), or directly to a computer running Dataton programming software. In this case, the relevant cable is included with the software and can be extended up to 20m with SYSTEM CABLE. SYSTEM CABLE is available in several standard lengths and as a DIY kit. When SMARTPAX QC is connected to TRANSPAX+, AIRLINK RECEIVER or MIC3+, the maximum cable length is 25m as SMARTPAX QC supplies power to the other unit. A pulsing yellow light from the LED adjacent to the **IN** connector indicates that correct data is being received from a previous device (on left, see picture on first page).



**OUT** Connects SMARTPAX QC to the next SMARTPAX QC unit in the chain via SYSTEM CABLE. A pulsing yellow light from the LED adjacent to the **OUT** connector indicates that correct data is being sent back to a previous device.



**TAPE** Connects SMARTPAX QC to a tape player using a phono cable. This means you can run the SMARTPAX QC from a Dataton SYNCODE cue track on tape rather than from computer. The SMARTPAX QC passes the cue track signal on to other units via the **OUT** connector and SYSTEM CABLE. The cable between the tape player and the SMARTPAX QC should be no longer than 2m. During playback, make sure that the tape player is connected to the first control unit in the chain. Never use both the **IN** and **TAPE** connectors at the same time; disconnect the computer when playing a cue signal through **TAPE**. A steady green light from the LED adjacent to the **TAPE** connector indicates that a correct SYNCODE cue track is being received. If the light starts flickering, try adjusting the playback level or, if the tape is old and worn, replace it with a new tape.



**ID** Shows the selected identity number for that specific SMARTPAX QC unit. During software configuration from TRAX, the ID number setting is stored in the TRAX show file as well as in the actual SMARTPAX QC. This number remains the same until SMARTPAX QC is reconfigured in TRAX, regardless of the physical setting. Positions 1 through 15 represent the ID number assigned to the SMARTPAX QC. This is the number used when addressing devices under control from TRAX. The physical ID selector setting is sensed during system configuration. If the selector is turned afterwards, the internal ID number remains the same, but the selector's backlight turns off, thus indicating that the physical setting no longer corresponds to the programmed ID number. The position indicated by the Dataton logo is used for system diagnosis (see the TRAX handbook for details).



Power and status indicators. **POWER** indicates that the unit is powered. **LOCAL** indicates that power is supplied locally through a 12V DC ADAPTOR on the back of the unit; **REMOTE** that power is supplied by a SMARTPAX QC via **OUT**. **FAILURE** indicates a bad power supply or software problems, see the TRAX handbook.

## REAR PANEL

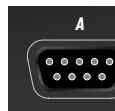

The devices to be controlled plug into the four device ports located on the back of the unit. One smartlink cable is used per port. The other end of the smartlink plugs into the device. Check the latest Dataton product catalogue or contact your Dataton dealer if you are not sure which smartlink you should use for a particular device. The letters A to D above each of the ports define, together with the ID selector setting on the front panel, the complete device address used by TRAX., eg, 3A, 7D.



**12V DC** Used to supply power to the SMARTPAX QC from a 12 DC ADAPTOR, article no: 3334. When power is supplied through this connector, the yellow **LOCAL** LED is lit on the front panel. Alternatively, the SMARTPAX QC may be powered by another SMARTPAX QC (or its predecessor SMARTPAX) connected to **OUT**. If this alternative way of powering the SMARTPAX QC is used, the **REMOTE** LED on the front panel is lit.

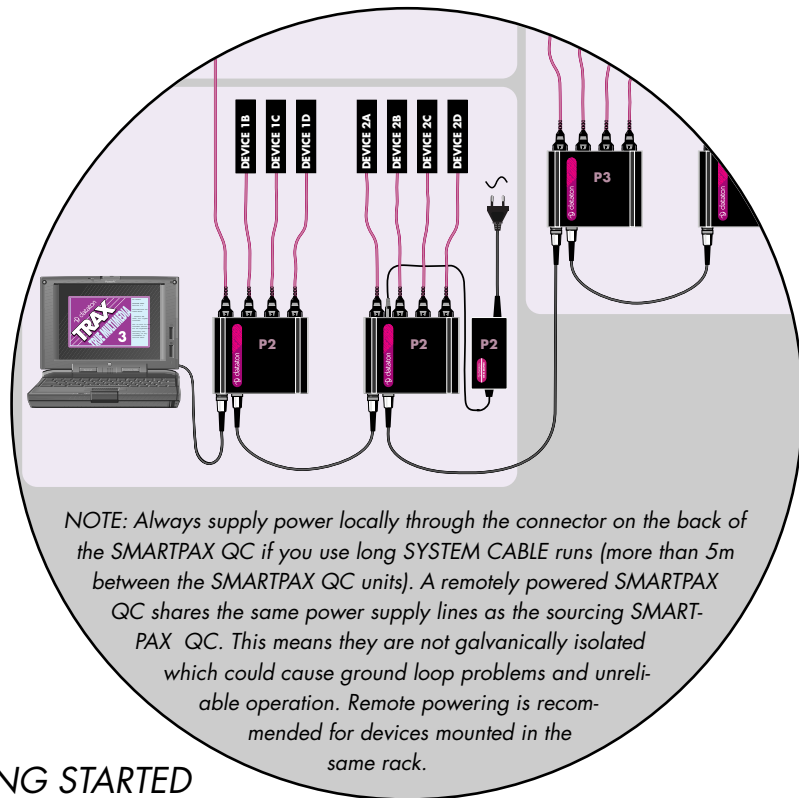

## GETTING STARTED

Connect the SMARTPAX QC to a computer running Dataton programming software (see previous sections on **IN**, **OUT** and **TAPE**) or as part of a chain of control units linked by SYSTEM CABLE. Plug the appropriate smartlink cables to the

SMARTPAX QC ports and the devices. Plug in the power supply to the SMARTPAX QC. Further configuration takes place in TRAX run on a MacOS based computer, see the TRAX handbook.



## DEVICE DRIVERS

To operate, SMARTPAX QC has to be configured from TRAX, ie, the appropriate software device drivers have to be downloaded into the SMARTPAX QC. They will remain there until you reconfigure it from TRAX, even if the power is switched off. The TRAX program includes several hundred device drivers covering control of most contemporary multimedia devices related to audio, video, slides, lighting, computer presentation, etc.

If there is no standard driver available for a particular device, you can make your own driver. Please refer to your TRAX handbook for more information on writing your own ASCII drivers and downloading drivers from TRAX.

An updated list of which devices can be controlled by SMARTPAX QC and which smartlink cables to use is available on Dataton's web site:

**<http://www.dataton.com>**

## IMPORTANT

SMARTPAX QC is fully upward compatible with its predecessor, SMARTPAX. It can use all the same device drivers and smartlink cables. Both kinds of units may be used in the same rig. TRAX, version 3.0.4 or later is required.

## TECHNICAL SPECIFICATIONS

**Size:** 157 × 125 × 30 mm  
(6.2" × 4.9" × 1.2")

**Weight:** 400 g

**Power consumption:** 12V DC ±10%  
150mA maximum (stand alone).

**Power supply connector:** According to EIAJ RC5320 class IV.

**Internal memory for storing device specific drivers:** 32 kB, nonvolatile.

**Maximum number of SMARTPAX units connected to one TRAX system bus:** 14

**Maximum length of SYSTEM CABLE between SMARTPAX units:** 100m (provided that power is supplied locally).

**System bus:** DATATON SMART-CODE™, a proprietary protocol for bidirectional communication between SMARTPAX units and a host computer, using optically isolated receivers with active termination.

**Device ports at rear:** 9-pin D-sub male connector, see connection diagram below. Electrically compatible with RS-232, though specs differ slightly.

**Device port protocol:** downloaded from TRAX. More than 400 protocols are available.

**Maximum serial data communication speed:** 230.4 kB/s.

**Maximum current source to connected devices:** (pin 8–9) 0.5A on one port, 1A totally on all.

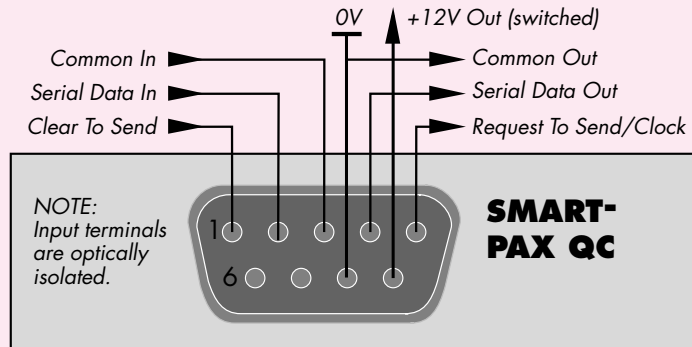

# TOUCHDOWN

Art. No. 3351



- **Analog, color touchscreen**
- **TFT display, VGA**
- **Motion detector**
- **MP3 playback and line out**
- **Rugged aluminium housing**
- **Handheld or DIN rail mount**

## GENERAL

TOUCHDOWN® is a color LCD touch panel that provides a stunning, dedicated user interface to your Dataton TRAX control system. Use TOUCHDOWN as a powerful controller, replacing the Macintosh computer in the show rig, or as a panel controlled by a TRAX system.

You design the TOUCHDOWN user interface in Dataton TRAX, available free from [www.dataton.com](http://www.dataton.com)

When TOUCHDOWN replaces the computer in a rig, the TRAX show is stored on a SmartMedia card. The card then slots into TOUCHDOWN. When TOUCHDOWN is used as a panel device in TRAX, functions are downloaded from TRAX via a SMARTPAX QC.

TOUCHDOWN can be loaded with up to 99 panel pages of buttons, sliders,

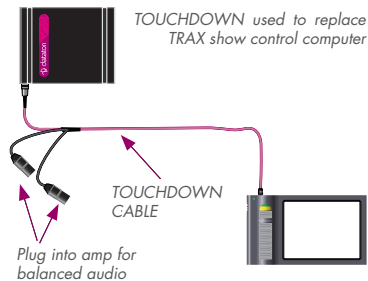

indicators, and images. It offers VGA resolution (640 × 480 pixels) with 8 bit color. The thin film transistor display ensures high brightness and optimized viewing angles.

TOUCHDOWN can play back MP3 audio with its built-in loudspeaker, and source balanced audio to an amplifier. You can also plug in earphones or a headset to the TOUCHDOWN.

## SMARTMEDIA CARD

The programmed SmartMedia card slots into the TOUCHDOWN with the gold surface face up. The card should not be visible from the front of the TOUCHDOWN. To remove a card, push it down into the slot again with the tip of your fingernail or a small screwdriver. The card will then pop up.

## CONNECTION

Use TOUCHDOWN CABLE, article number: 3467 to connect TOUCHDOWN to the Dataton system.

The TOUCHDOWN CABLE has three connectors. Two of them provide balanced audio to an amplifier. The third may be used in two ways.

When TOUCHDOWN is used as the show brain, the third connector plugs into the IN jack on the first SMARTPAX QC in the rig. If the TOUCHDOWN

is used as a panel device, the TOUCHDOWN CABLE connects to a SYSTEM IN SMARTLINK (article no: 3477). The SYSTEM IN SMARTLINK then plugs into the device port on the SMARTPAX QC.

Extend with SYSTEM CABLE.

TOUCHDOWN PRODUCER KIT, article no: 3651, includes accessory cables and a SmartMedia writer/reader.

## POWER SUPPLY

TOUCHDOWN will normally receive power from SMARTPAX QC; from the IN connector when the TOUCHDOWN replaces the show computer, and from the device port when TOUCHDOWN is used as a controlled panel.

Supply power independently:

- When you have more than 5m between the SMARTPAX QC and the TOUCHDOWN.
- When you want to connect more than one TOUCHDOWN to the same SMARTPAX QC unit.
- When there are other devices connected and powered from the same SMARTPAX QC.

To supply power separately, use a 12V DC ADAPTOR, article number 3334. One end of the adaptor plugs into a regular power outlet and the other into the power jack on the upper edge of the TOUCHDOWN.

## TOUCHDOWN Overview

### Screen

- 640 × 480 pixel backlit TFT display.
- 8 bit color.
- High resolution touch surface.

### Memory

- 16 MB internal, non-volatile FLASH.
- 4 to 64 MB SmartMedia 3.3 Volt.
- 16 MB RAM.

### Graphics

- Up to 99 pages of custom graphics.
- Two fonts, three sizes, two weights.

### Sound

- MP3 sound.
- Balanced audio output.
- Plug for earphones.
- Loudspeaker.
- 1 hour full audio quality with SmartMedia card.

### Usability

- Power requirements: 12 V DDC, 700mA maximum.
- Motion sensor controls display lighting and programmable functions.
- 2m connection cable may be extended to 30m (external power).

- One-off setup for image preferences, backlighting, wake-up and power.
- Aluminum housing.
- Programmable triple function button.

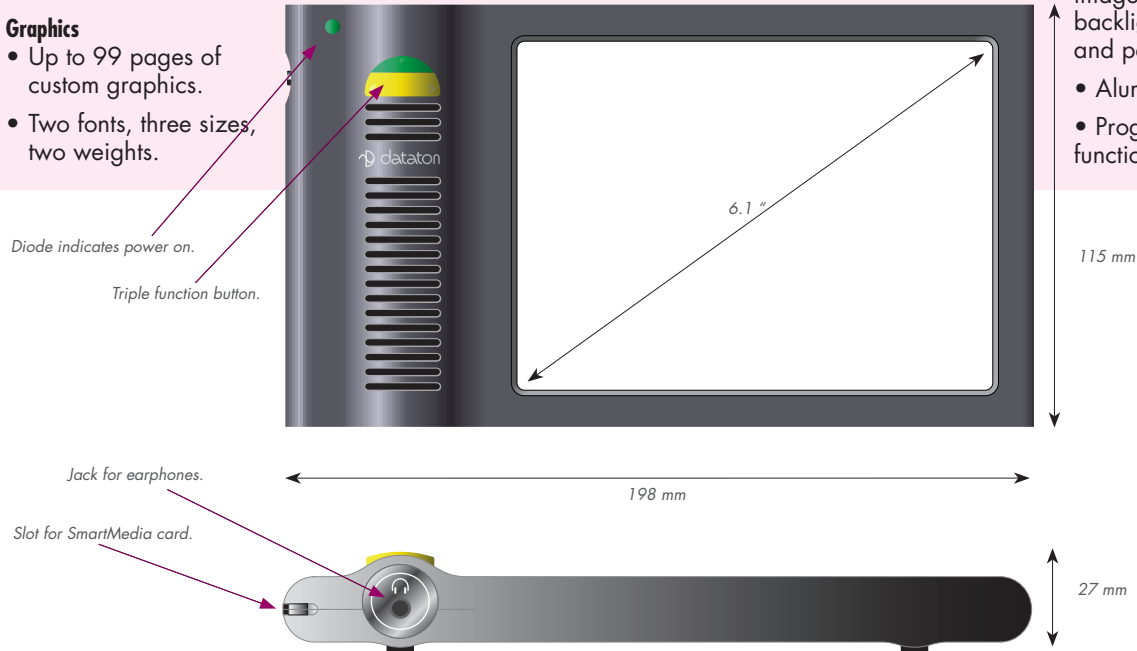

# AIRLINK TRANSMITTER

Art. No. 3448



*AIRLINK TRANSMITTER and AIRLINK RECEIVER form a complete wireless remote control system.*

*Use AIRLINK with Dataton PAX or SMARTPAX for direct control of up to four slide projectors including dissolve and random access functions, or with Dataton MIC-TOUCH for controlling a presentation environment. The AIRLINK system also*

*provides remote control of Apple Macintosh computers running Dataton TRAX for speaker support and interactive applications.*

*AIRLINK TRANSMITTER is shipped complete with an AIRLINK OVERLAY KIT so you can customize your transmitter.*

## USAGE

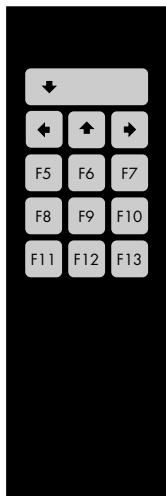

**With TRAX** Connect the AIRLINK RECEIVER to the ADB port of the MacOS computer running TRAX, using the AIRLINK MAC ADAPTOR. If no ADB ports are free, use an ADB expansion box or Y cord for connection. The top four keys on the transmitter mimic the arrow keys on the Macintosh keyboard as used in TRAX. The big key acts as the down arrow key, running the show to the

next cue on the current track. Use the right arrow key to skip ahead to the next cue on the current track. The left or up arrow will rewind the show to the previous cue on the current track.

The remaining nine keys mimic function keys F5 to F13 on the Apple Extended Keyboard. In TRAX, these are used to jump directly to any position in the show using System cues F5 to F13. See the TRAX handbook for more details on creating and using System cues.

**AIRLINK  
TRANSMITTER**

**TRUEMULTIMEDIA**

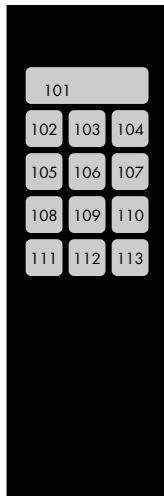

**With MICTOUCH** Plug the AIRLINK RECEIVER into the **DATA IN** connector on the MICTOUCH. AIRLINK TRANSMITTER acts as a slave MICTOUCH, adding more keys to the master unit. These are numbered from 101 if connected directly to the master, from 201 if connected to the first slave, and so on.

*Note:* MICTOUCH has been discontinued.

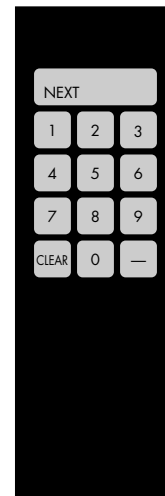

**With PAX or SMARTPAX** Connect the slide projectors and AIRLINK RECEIVER to PAX or SMARTPAX. The receiver plugs into the **IN** port and the projectors to the four ports on the back of the control units via projector adaptors or smartlink cables. The big key acts as a NEXT key, advancing to the next slide. If you are using more than one projector, this will be done by a one second dissolve; otherwise the tray will simply advance.

The numeric keys are for random access of slides. Enter the slide number you want, then press the NEXT key to get there. The bottom left key, CLEAR, lets you cancel an entry. Use the bottom right key to reverse one slide.

In the AIRLINK system, slide number 1 is in the first projector's first slot, slide 2 will be in the first slot of the second projector (if any), and so on. Remember to load your slide trays accordingly.

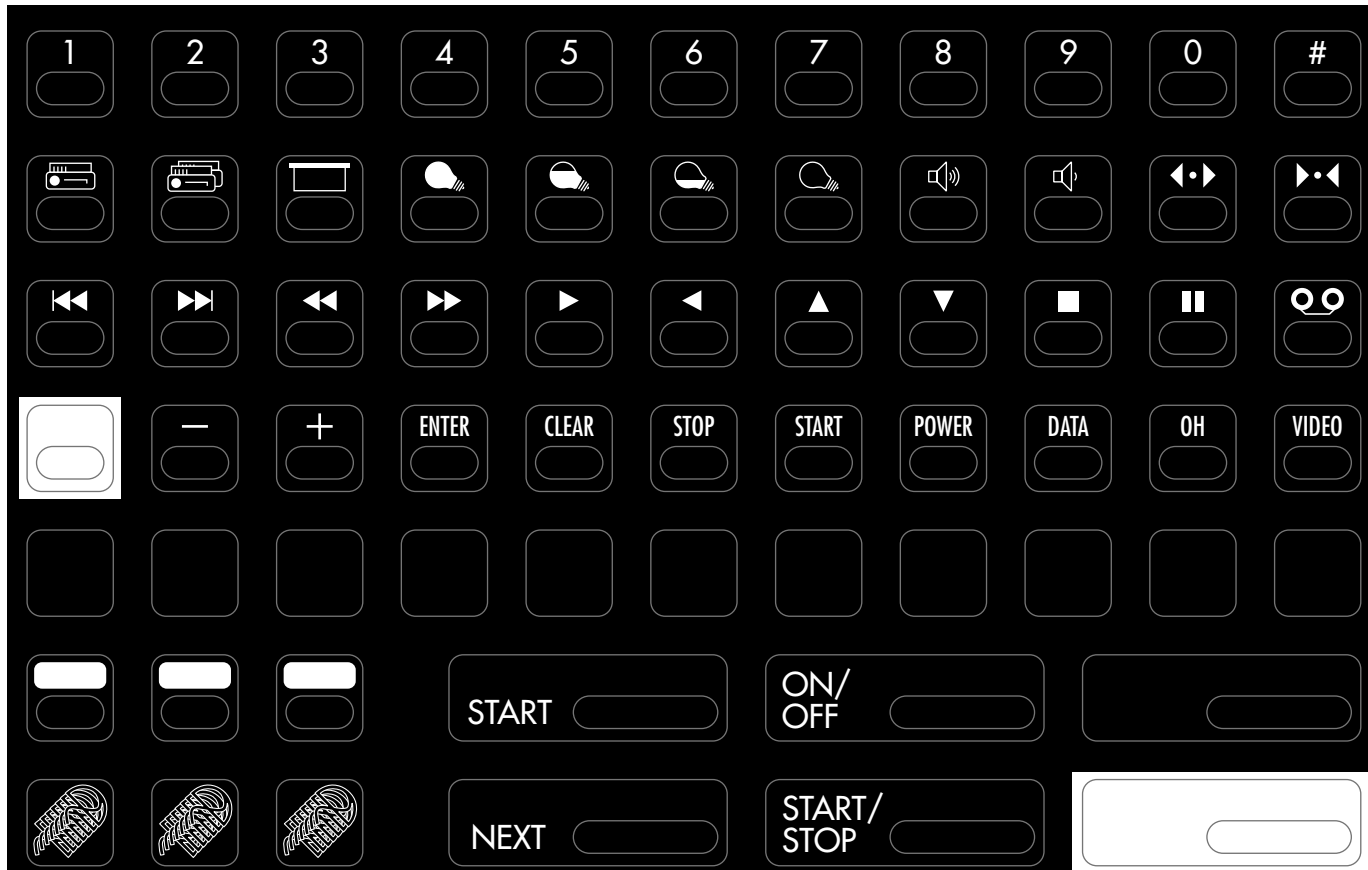

**KEY LABELING** The transmitter's 13 keys can be labeled according to their functionality using the AIRLINK OVERLAY KIT. In addition, unused keys can be removed and covered with blanks. To do this, unscrew the front of the transmitter and remove the relevant key caps. Put the transmitter back together again, gently tightening the screws, and apply the blank stickers.



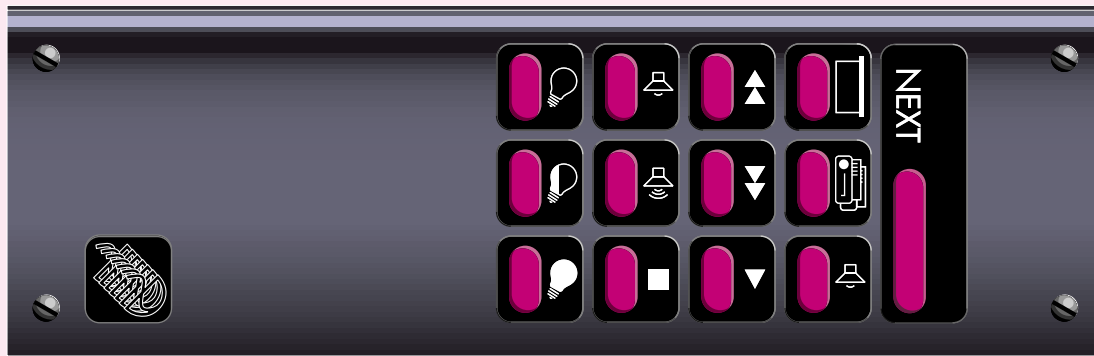

## Technical Description

*Transmitting range:* Depends on environment parameters, typically > 10m (30 ft).

*Power source:* 3 cell Lithium 2000 mA, expected endurance under normal conditions: >10 years. The power source is permanently installed and cannot be replaced by the user.

*Infrared protocol:* PPM™ (Power Pulse Modulation), a Dataton proprietary protocol, readable by AIRLINK RECEIVER.

*IR transmitter hardware:* 8 high efficiency GaAlAs, 850 nm peak wave length IR diodes.

*IR diode driver circuit:* High efficiency fly-back dual MOSFET drivers with >95% energy conversion factor.

*Key assignment:* By software in TRAX. Keys are custom labeled by the user by means of the enclosed label sheet.

*Dimensions:* 47×17×150mm. Extruded aluminum case.

For more information, please refer to product sheets for AIRLINK RECEIVER and control units, and Dataton TRAX® documentation.

# AUDIO SMARTLINK

Art. No. 3493

*AUDIO SMARTLINK is a high performance audio mixer controlled from one port of Dataton SMARTPAX QC. It is the ideal way to integrate audio level control in your multimedia rig.*

*AUDIO SMARTLINK features eight inputs, two outputs, and is programmed from Dataton TRAX®.*

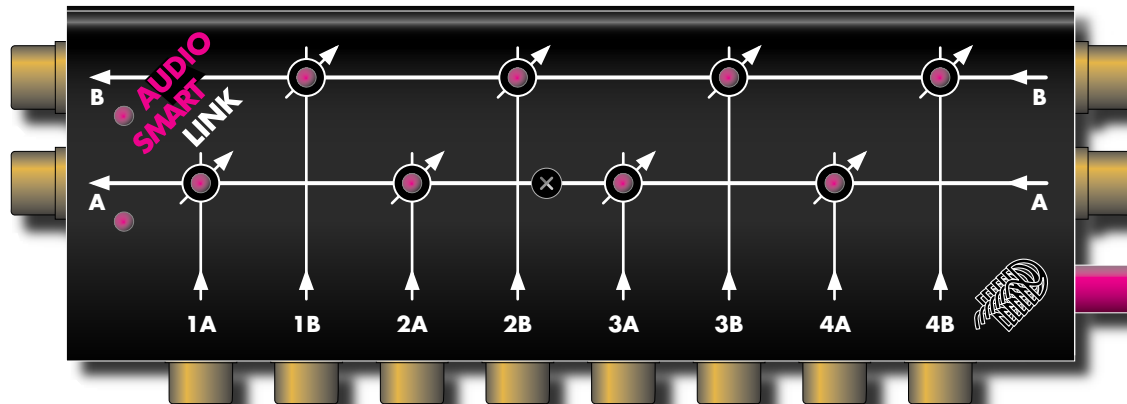

dataton

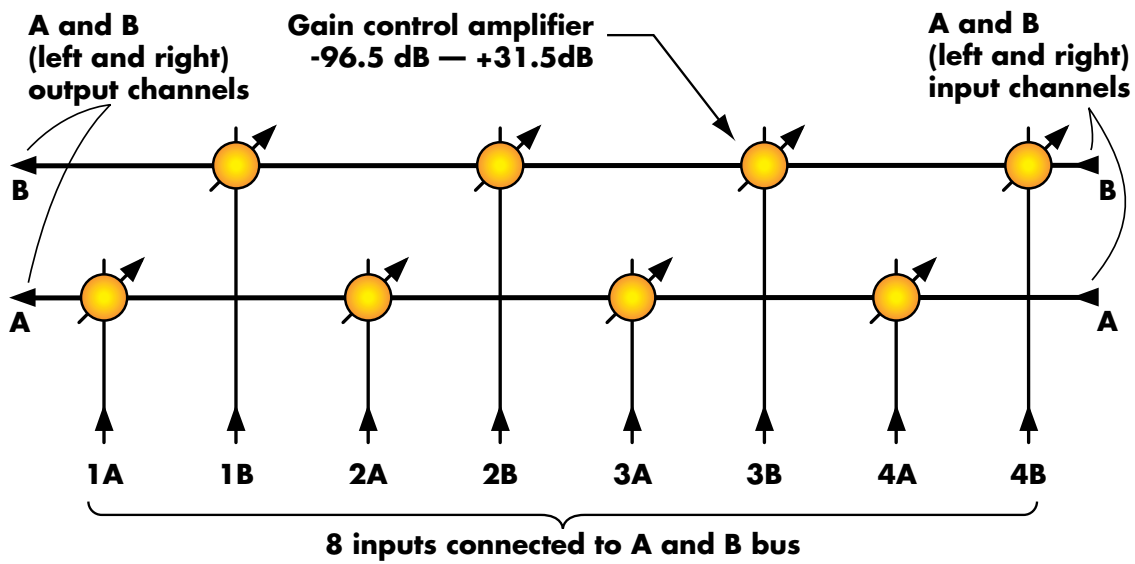
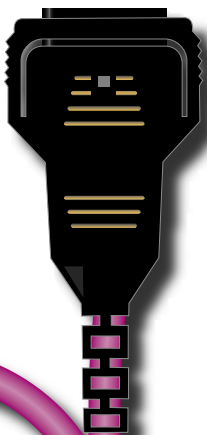

*Inside AUDIO SMARTLINK*

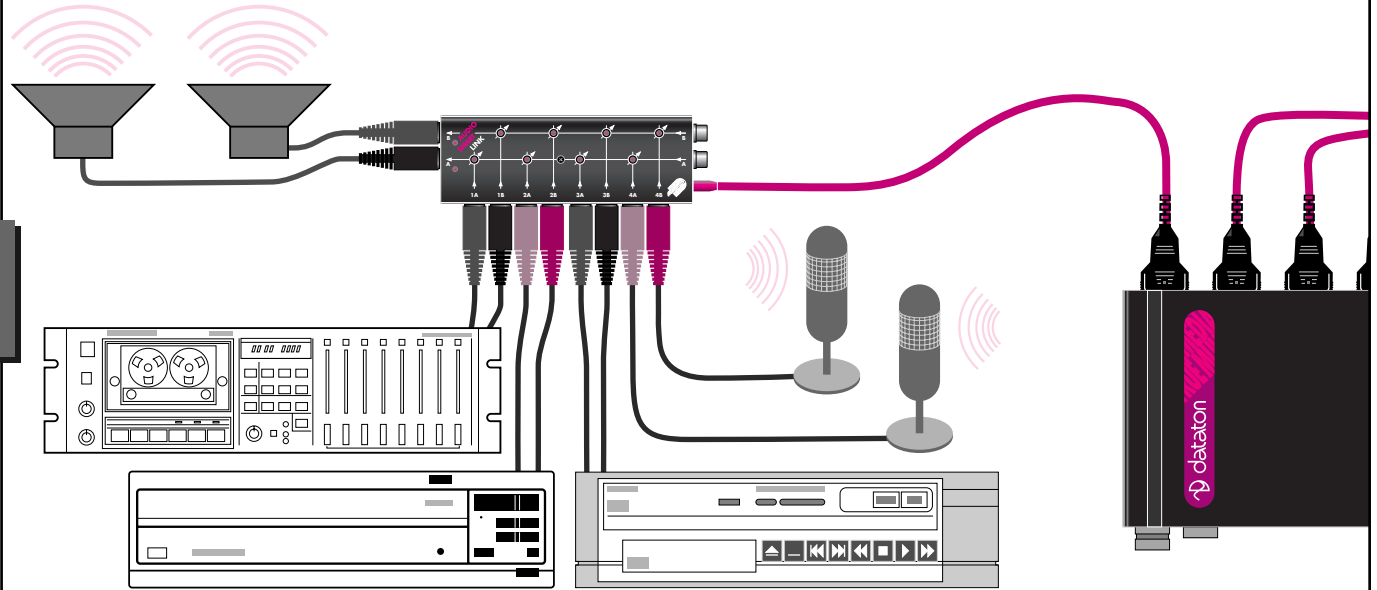

*Possible set-up using AUDIO SMARTLINK*

## GENERAL

AUDIO SMARTLINK is an eight input/two output audio mixer (four stereo pairs) and is used as part of the Dataton control system. Two additional fixed inputs allow multiple units to be cascaded for increased input capacity.

The gain in each of the eight amplifiers may be set between +31.5 dB and -95.5 dB, making it useful for high-level output microphones and line-level audio signals.

The control path is isolated from the audio circuitry in AUDIO SMARTLINK to avoid ground loop problems among the audio gear and the rest of the rig.

## PROGRAMMING

For details on how to program AUDIO SMARTLINK with Dataton TRAX, please refer to the device information database available from within TRAX or the TRAX user's guide.

## IMPORTANT

To avoid excessive clipping and distortion, please ensure that input signals have no DC components. This is normally not a problem for audio signals originated from standard audio sources.



## Technical Description

- Frequency response: 0-35 KHz
- Dynamic range: 110 dB
- THD+N: < 0.001%
- Max signal level: +10 dBu
- Control range: -95,5 to +31,5 dB (0,5 dB steps)
- Gain control: To avoid audible interference, gain control takes place while signal is zero crossing.
- Inputs: Unbalanced 10 K $\Omega$ .
- Output: Unbalanced, 600  $\Omega$  driving capability.
- LEDs on front panel indicate overloading on the associated amplifiers.

The AUDIO SMARTLINK cable is 1.6m (63") long and may be extended with Dataton EXTENSION CABLE, article number 3451 (1m), 3452 (2m) or 3455 (5m).

AUDIO SMARTLINK measures 47 × 17 × 125 mm, connectors and cable excluded.



# SIMDA SMARTLINK

Art. No. 3476

*Smartlink cables are used to connect audiovisual devices to Dataton SMARTPAX QC multimedia control units.*

*SIMDA SMARTLINK lets you control TAV Simda slide projector models 3262 ALC and 3462 ALC.*

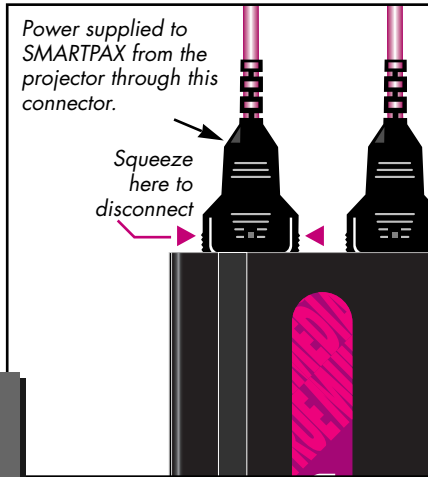

## INSTALLATION

SIMDA SMARTLINK connects TAV Simda projector models 3262 ALC or 3462 ALC to SMARTPAX. The SIMDA SMARTLINK connects via a 6 pin DIN plug.

Connect the snap-lock connector to the back of the SMARTPAX and the other end of the smartlink to the RS232 port on the projector.

## IMPORTANT

The SIMDA SMARTLINK requires projectors using software version 3.3 or later.

Always connect the smartlink before turning on the power to the projector. Plugging or unplugging the smartlink with the power on may cause damage.

Connect all projectors controlled from one SMARTPAX to the same mains outlet to avoid ground loop problems. Projectors controlled from different SMARTPAX units may be powered from different mains outlets. SMARTPAX receives power from the projector connected to the leftmost output (front view).

## CONFIGURATION

In most cases, SMARTPAX is configured automatically from Dataton TRAX. You must, however, manually set the SMARTPAX port address to correspond to the device's address in TRAX.

If you are using the manual mode in TRAX, you will need to configure the SMARTPAX using its port, address and device buttons.

Please refer to the SMARTPAX product sheet and the TRAX handbook for more details.

## PROGRAMMING

Consult your Dataton TRAX handbook for details on how to program projector applications.

## Technical Description

SIMDA SMARTLINK connects Simda projector models 3262 ALC or 3462 ALC to SMARTPAX. This smartlink uses a proprietary serial protocol. The projectors are programmed from Dataton TRAX®.

The SIMDA SMARTLINK cable length is 1.6m (63") and may be extended with Dataton EXTENSION CABLE, article number 3451 (1m), 3452 (2m) or 3455 (5m).

Pin number at SMARTPAX end  
Color code  
Signal symbol  
Pin number at Simda end

1			
2	Red	TxD	5
3	Orange	GND	6
4	Yellow		con. case
5			
6	Blue	GND	6
7	Violet	30V DC	3
8	White	GND	6
9			
		Screen	





# MIDI SMART- LINK

Art. No. 3470

*MIDI SMARTLINK allows you to control most devices compatible with the MIDI standard.*

## INSTALLATION

Plug the snap-lock connector into one of the ports on the back of a SMARTPAX QC. Plug the male DIN connector into the MIDI IN port of the device you want to control.

## CONFIGURATION

In most cases, SMARTPAX is configured automatically from Dataton TRAX. You must, however, manually set the SMARTPAX port address to correspond to the device's address in TRAX. If you are using the manual mode in TRAX, you will need to configure SMARTPAX using its port, address and device buttons. Please refer to the SMARTPAX product sheet and the TRAX handbook for more details.

The following MIDI-related drivers are available:

- MIDI channel drivers, for issuing note-on/note-off messages to a sampler or synthesizer for sound effects.

- Specialized drivers for lighting consoles and other non-musical devices.

MIDI SMARTLINK is also capable of receiving MIDI commands from devices that can supply Note On, Note Off and level change functions.

## PROGRAMMING

You program a MIDI-timecode device in the same way as you program a tape player, ie, using Locate and Trigger cues in Dataton TRAX. When a Locate cue is received, SMARTPAX transmits a short burst of MIDI timecode, forcing the device under control to jump to that point in time. SMARTPAX then stops the timecode at the exact start position until it receives a Play command.

When this is received, the SMARTPAX begins transmission of continuous timecode until a subsequent Stop Locate cue is received.

MIDI channel drivers are programmed using a TRAX Locate cue, which specifies the MIDI note number, or zero, to turn the note off. You can use a Level cue to set the velocity prior to issuing the Locate cue.

Lighting consoles and other specialized devices are also usually programmed using Locate cues. For more details, refer to the specifications for the relevant

device driver in the TRAX driver database. These will also tell you how to configure the device itself in order to work with the SMARTPAX.

With TRAX 3.0 in its interactive mode, it is also possible to receive MIDI Note On, Note Off and control change inputs from this smartlink. To do this, connect your MIDI device to the female 5 pin DIN connector on the MIDI SMARTLINK. Create a Switch device and select the appropriate driver inside the device's dialog box. Specify an address and a subaddress, where the subaddress corresponds to the note number for response. The note numbers are centered around middle C; ie, subaddress 16 corresponds to this.

To start an action when a key is struck, add a task to the Task list in TRAX 3.0 and link the triggering condition field to the "Input On" status field of the switch representing the button.

Please note that these MIDI input functions are not available with versions of TRAX prior to 3.0 or with MICSOFTE.

## TECHNICAL SPECIFICATIONS

MIDI SMARTLINK is the physical control link between the Dataton system and a MIDI compatible device. The selected device driver downloaded in SMARTPAX handles the protocol of the device under control. This includes anything from simple note-on/note-off messages, through MIDI timecode, to specialized functions such as control of MIDI compatible lighting consoles. Functions are programmed from Dataton TRAX®.

One male 5-pin DIN connector is provided for MIDI out and one female 5-pin DIN connector for MIDI in. MIDI SMARTLINK has a standard cable length of 1.6m (63"). If necessary, you can extend this with Dataton EXTENSION CABLE, article number 3451 (1m), 3452 (2m) or 3455 (5m).



# AIRLINK RECEIVER

*AIRLINK RECEIVER is used together with AIRLINK TRANSMITTER for wireless remote control in conjunction with Dataton SMARTPAX QC or a MacOS computer running Dataton TRAX. AIRLINK RECEIVER is shipped complete with an AIRLINK MAC ADAPTOR cable and a SYSTEM IN SMARTLINK. It connects directly to SMARTPAX QC for slide projector control or via the cables listed above to SMARTPAX or a Macintosh as an input device.*

Art. No. 3449

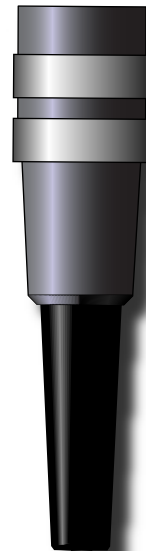

## USAGE

**Speaker support** For remote control of TRAX, connect the receiver to the Macintosh's ADB port using the AIRLINK MAC ADAPTOR. If no ADB ports are free, use an ADB expansion box or Y cord for connection. AIRLINK can also be used as a remote control unit for other Mac presentation graphics programs that use a similar set of keystrokes to perform functions. Always connect the receiver before powering the computer.

### Slide projector control

For direct control of up to four slide projectors, plug the AIRLINK RECEIVER into the **IN** port on the SMARTPAX.

Select the appropriate device driver and address using the PORT, DEVICE and ADDR buttons on the SMARTPAX. Start with address 10 for the first projector, 11 for the second and so on. Connect the projectors to the SMARTPAX with the appropriate smartlink cables, beginning with the leftmost port (front view).

*Dataton PAX (no longer manufactured) can also be used for slide projector control. To do so, set **BANK** at 1L and the **OBJECT** selector according to the type of projector. Starting with the leftmost PAX port (front view), connect the projectors with PAX adaptor cables.*

**Interactive control** Connect the receiver to one of the SMARTPAX unit's four ports with the enclosed SYSTEM IN SMARTLINK. Read more about how to program its functions in the TRAX 3 handbook available free of charge from the Dataton web site: [www.dataton.com](http://www.dataton.com)

## IMPORTANT

Connect all wires and switch on all projectors or other devices before you start to operate the AIRLINK system. If control units are powered from slide projectors, either turn on all projectors with a common power switch or turn on the projector connected to the unit's leftmost port (front view) last, as this projector supplies power to the control unit. If power is supplied through the control unit's 24V AC EXT POWER input, turn on all projectors before turning on the external power supply.

## Technical Description

**Reception range:** Depends on environmental parameters, typically >10m (30 ft). The receiver is very sensitive ensuring maximum operational range. Avoid placing near incandescent lamps or in direct sunlight.

**Infrared protocol:** PPM™ (Power Pulse Modulation), a Dataton proprietary protocol, transmitted by Dataton AIRLINK TRANSMITTER.

**IR receiver hardware:** Integrated IR receiver/amplifier circuit connected to DSP-type of microprocessor function.

**Dimensions:** 54x29x10mm. Extruded aluminum case.

For more information, see the product sheets for AIRLINK TRANSMITTER and SMARTPAX QC, and the Dataton TRAX® handbook, all available at [www.dataton.com](http://www.dataton.com).

The receiver's 2m lead can be extended up to 25m with SYSTEM CABLE. If connected to the ADB port of a Macintosh, the lead may only be extended up to 5m. Avoid this if possible by moving the computer.

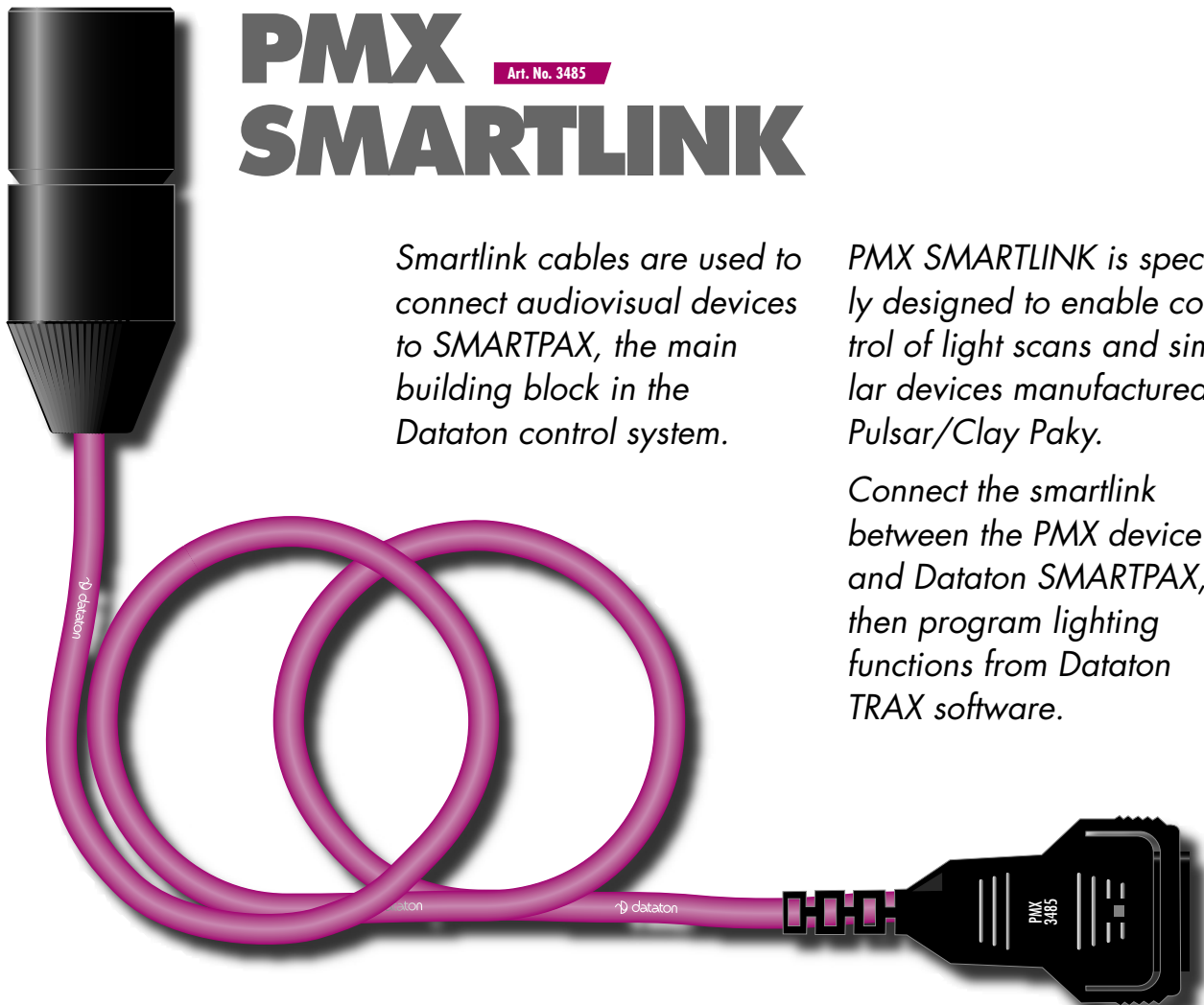

# PMX SMARTLINK

Art. No. 3485

*Smartlink cables are used to connect audiovisual devices to SMARTPAX, the main building block in the Dataton control system.*

*PMX SMARTLINK is specially designed to enable control of light scans and similar devices manufactured by Pulsar/Clay Paky.*

*Connect the smartlink between the PMX device and Dataton SMARTPAX, then program lighting functions from Dataton TRAX software.*



## INSTALLATION

Always connect the smartlink to the device and the SMARTPAX before turning on the power. Plugging or unplugging with the power on may damage the equipment! Try to keep the cable between the SMARTPAX and the device as short as possible to minimize ground loops.

For information on how to program lighting sources using Dataton TRAX, please refer to your TRAX handbook.

## SMARTPAX CONFIGURATION

In most cases, SMARTPAX is configured automatically by Dataton TRAX. You must, however, manually set the SMARTPAX port address to correspond to the device's address in TRAX.

If you are using the manual mode in TRAX, you will need to configure the SMARTPAX using its port, address and device buttons.

Please refer to the SMARTPAX product sheet and the TRAX user's guide for more details.

## Technical Description

PMX SMARTLINK can be used to connect SMARTPAX to several serial controllable devices manufactured by Pulsar/Clay Paky. Contact your Dataton dealer for advice on which smartlinks to use with the various brands and models of device, or consult the device database in Dataton TRAX® for detailed information.

The PMX SMARTLINK cable length is 1.6m (63") and may be extended with Dataton EXTENSION CABLE, article number 3451 (1m), 3452 (2m) or 3455 (5m).

Pin number at SMARTPAX end	Color code	Signal symbol	Pin number at 5-pin XLR end
1	Brown	Busy<	
2	Red	RxD<	
3	Orange	RxGND	
4	Yellow	TxD>	2
5	Green	Ready>	
6			
7			
8	White	TxGND	3
9			
		Screen	1



# RELAY SMARTLINK

Art. No. 3494

*RELAY SMARTLINK is used with Dataton SMARTPAX to control relay functions for audio equipment, LEDs and*

*lamps; voltage functions, such as AC/DC motors, and power switching. It incorporates two electromechanical relays housed in a 15 pin D-sub connector.*



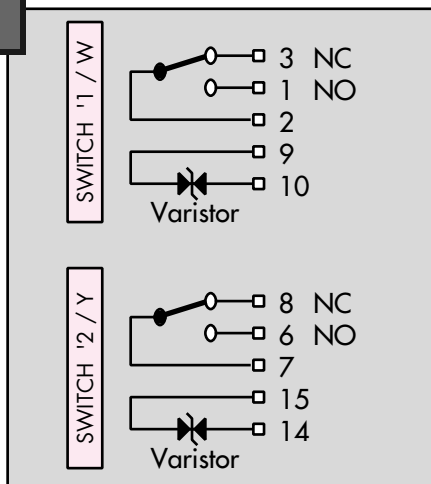
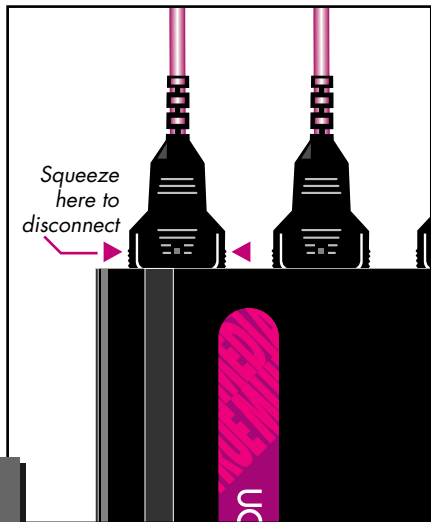

## USAGE

Plug the smartlink's snap-lock connector into one of the four ports on the back of SMARTPAX. The other end connects to the device to be controlled.

The two LEDs on the D-sub connector indicate the status of each relay contact. An illuminated LED means that the relay contact is active. In the schematic (left) the relays are in a passive state.

## CONFIGURATION

In most cases, SMARTPAX is configured automatically from Dataton TRAX. You must, however, manually set the SMARTPAX port address to correspond to the device's address in TRAX. If you are using the manual mode in TRAX, you will need to configure the SMARTPAX using its buttons. Please refer to the SMARTPAX product sheet and the TRAX handbook for more details.

## IMPORTANT

The built-in arc suppression varistors must be connected in parallel with the relay contact whenever inductive loads are switched, eg, motors or power relays. This protects the relay switch from the high voltage spikes created by such loads.

## Technical Description

RELAY SMARTLINK contains two, independent SPDT (single-pole, double-throw) electromechanical relays housed in a 15 pin D-sub connector.

The relay contacts withstand 2A and 24V AC/DC. RELAY SMARTLINK features built-in optional arc suppression varistors for use with inductive loads.

The length of the cable attached is 1.6m (63") and may be extended with Dataton EXTENSION CABLE, article number 3451 (1m), 3452 (2m) or 3455 (5m).

# POWERLINK

Art. No. 3497

*POWERLINK features eight independent relay outputs and eight independent inputs. Use it as part of your Dataton system to switch electrical devices, like lamps or motors, or to connect external switches such as custom-made keypads, etc.*

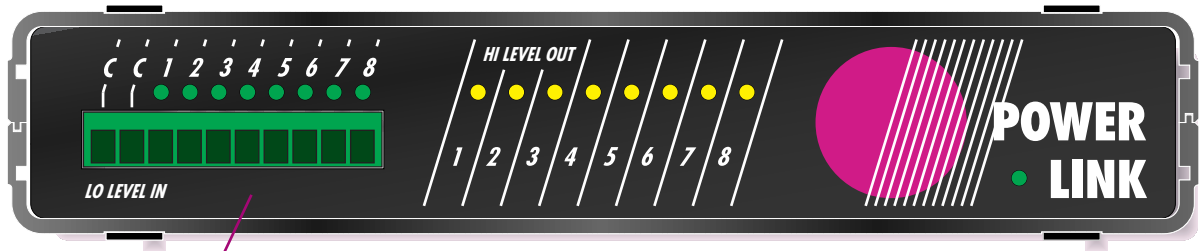

*POWERLINK front panel view.  
Green LED indicators show input level status.  
Yellow LED indicators show power relay status (accessed from the rear panel, more info on page 4).*

*POWERLINK has a power handling capacity of 10A, 230V AC. Four units may be daisy-chained to a single SMARTPAX port, making POWERLINK an effective and economical resource for relay control. Detachable screw terminals and two connection cables for daisy-chaining are shipped with each POWERLINK unit.*

## USAGE

POWERLINK is used with the SMARTPAX QC control unit in the Dataton system.

To connect POWERLINK to a SMARTPAX QC, use the enclosed cable, 3443 SMARTBRANCH FIRST CABLE. The snaplock connector plugs into a SMARTPAX QC port. The modular connector goes to the IN port on the POWERLINK.

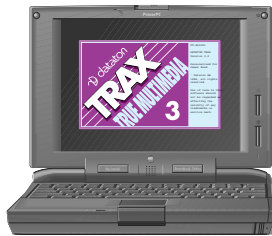

Multiple  
POWERLINK  
hook-up

## CONNECT MORE UNITS

To connect additional POWERLINK units on the same SMARTPAX QC port, use the enclosed black cable, 3444 SMARTBRANCH LINK CABLE.

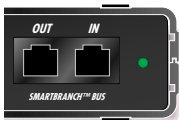

This modular/modular cable goes from the **OUT** port of the first POWERLINK, to the

**IN** connector on the second unit. In this way, you can run up to four POWERLINK units from the same port. The green LED adjacent to the IN connector indicates that the upstream data connection is functioning. When this LED flickers, it is an indication of normal data transmission between units.

You may mix POWERLINK and KEYLINK units on the same SMARTPAX port. The remaining ports may be used to control more POWERLINK or KEYLINK units, or unrelated media devices as required.

Please note: You may connect a maximum of eight POWERLINK units to a single SMARTPAX QC. This is due to power supply constraints; operating power for POWERLINK is entirely supplied by SMARTPAX QC. If your installation calls for more than eight POWERLINK units, distribute them on more than one SMARTPAX QC unit, in order to ensure reliable operation.

## INSTALLATION HINTS

POWERLINK units may be rack mounted by means of 3450 ONE U RACK BAY. This is usually the most suitable way to mount units in fixed installations.

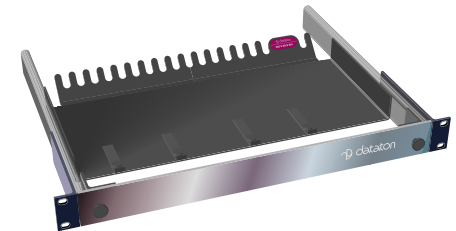

## PROGRAMMING

POWERLINK functions are accessed and programmed from Dataton TRAX control software, version 3.6.1 or later, available free of charge from Dataton's web-site: [www.dataton.com](http://www.dataton.com)

To program POWERLINK, create a Switch device in TRAX and select Dataton POWERLINK on the Type pop-up menu.

Specify a port and a subaddress corresponding to the output/input number on the unit. Set the Function to input, output or both as appropriate.

If you are running multiple POWERLINK units on the same SMARTPAX QC port, use subsequent subaddresses for the additional inputs and outputs, eg, use

subaddress 9 for the first input/output on the second POWERLINK, and so on. To program the outputs, use a Trigger cue set to On, Off, Pulse or Toggle and assigned to the switch device(s) to be controlled.



For full details, please refer to the information database inside Dataton TRAX.

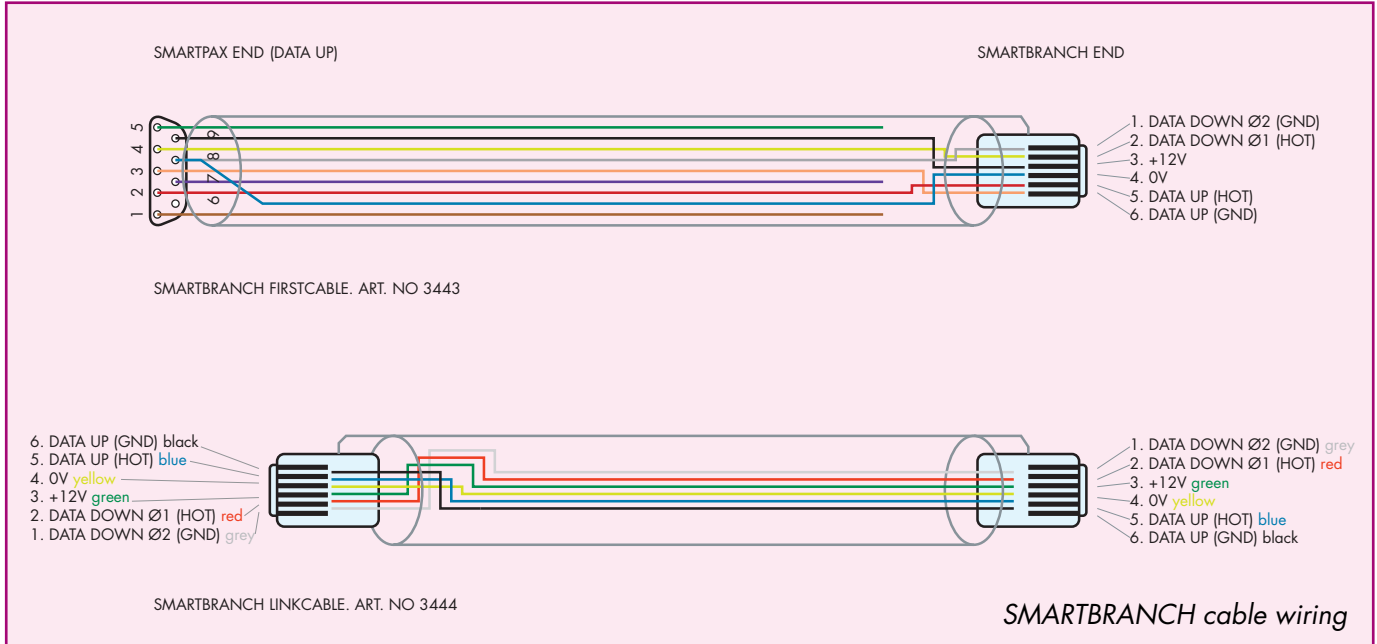

## Technical Description

POWERLINK has eight independent relay outputs and eight independent low level digital inputs. Separate, detachable screw terminals for inputs and outputs. Up to four units can be daisy-chained on one SMARTPAX port. POWERLINK and KEYLINK units can be freely mixed on the same port.

**Warning: Installation of POWERLINK in line voltage applications, ie, switching on and off line operating functions, must always be carried out by an authorized electrician.**

## Technical Specifications

*Relay power handling capacity:*  
10A, 250V AC, 30V DC maximum.  
10 mA, 5V DC minimum.

Power relays are accessed from the rear panel. Connections are carried out by means of the jackable screw terminal included.

*Arc suppression:*  
Relay switches have integrated arc arrestor circuits limiting relay voltage due to inductive kickbacks to 425V @ 500V/s and to 800V @ 100V/ $\mu$ s).

*Safety specifications:*  
In accordance with LVD 73/23/EEC as amended by 93/68/EEC.

*Logic input characteristic:*  
Solid state (DC only), with built-in 3.3k $\Omega$  pull-up to +12V internal supply. Connect input pin to common ground pin to activate the input. All inputs and outputs have LED indicators on the front panel.

Logic inputs are accessed from the front panel and connections are carried out by means of the low-voltage screw terminal included. Common terminals are labeled "C".

*Software compability:*  
Use with Dataton TRAX, version 3.6.1 or later, and Dataton SMARTPAX QC.

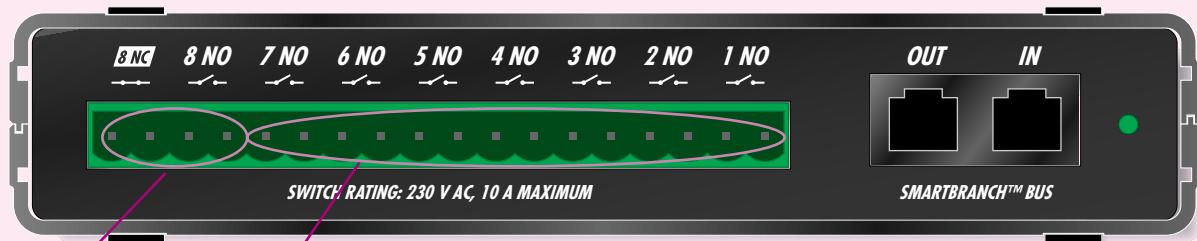

Relay switch  
no 8 is double pole,  
one normally open, one  
normally closed, eg,  
for SPDT applications.

Relay switches  
nos 1–7 are single pole,  
normally open type.

POWERLINK, article number 3497  
Size: 157×125×30mm (6.2"×4.9"×1.2"). Weight: 400 g  
Shipped with cables 3443 and 3444

# RS232 SMARTLINK

Art. No. 3480

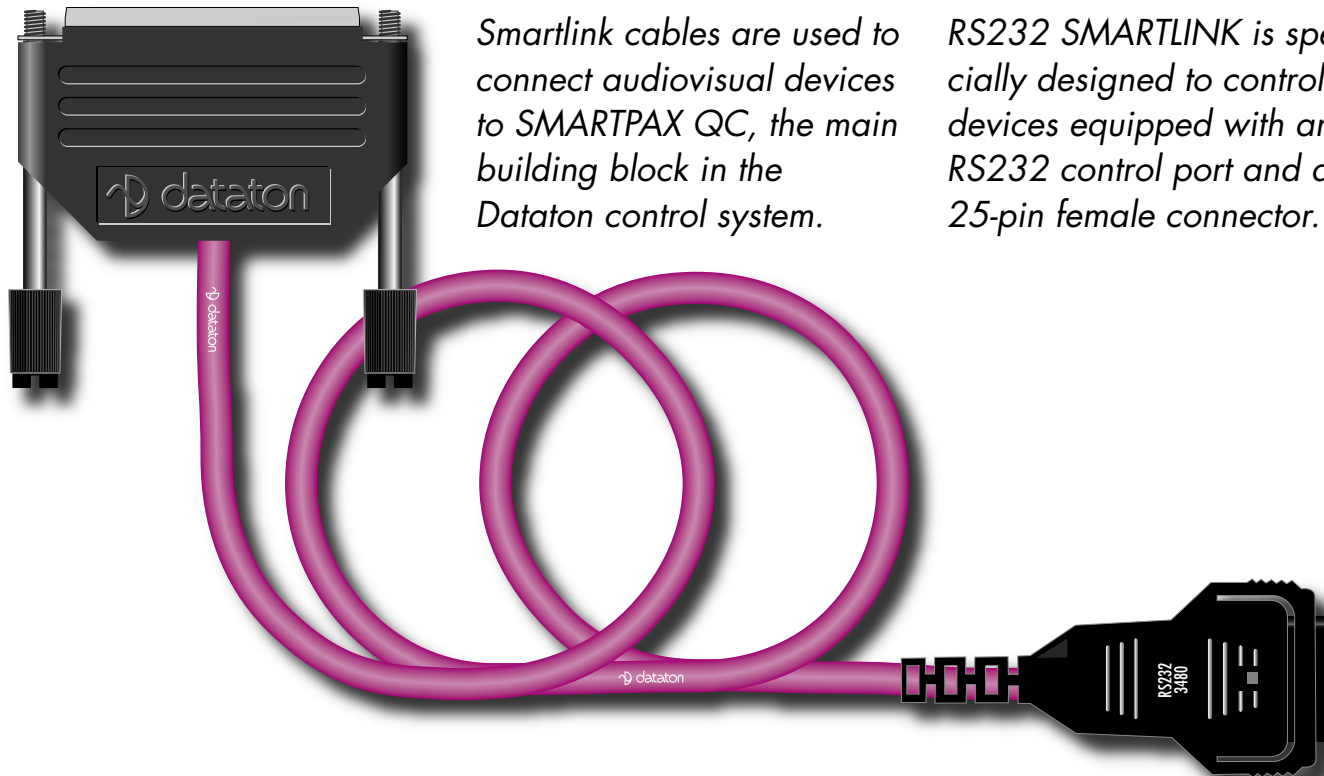

*Smartlink cables are used to connect audiovisual devices to SMARTPAX QC, the main building block in the Dataton control system.*

*RS232 SMARTLINK is specially designed to control devices equipped with an RS232 control port and a 25-pin female connector.*

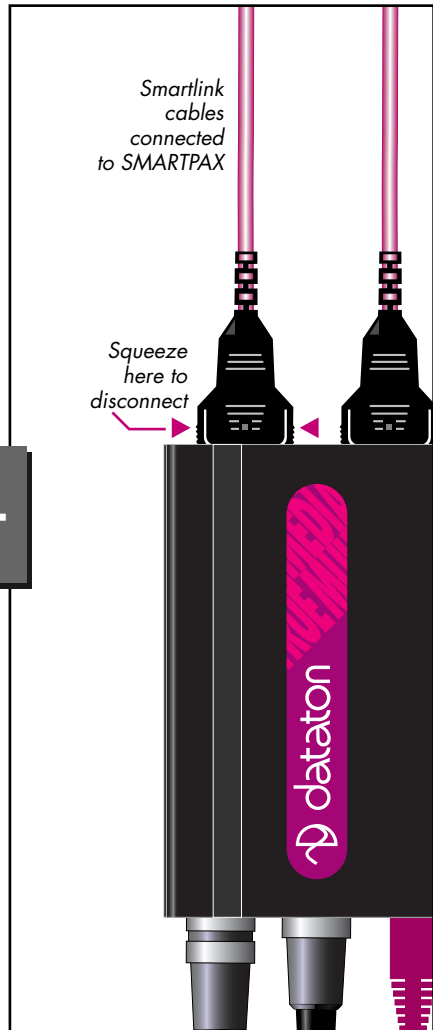
RS232  
SMART-  
LINK

## INSTALLATION

Always connect the smartlink to both the device and the SMARTPAX before turning on the power. Plugging or unplugging with the power on may cause damage to the equipment! Try to keep the cable between the SMARTPAX and the device as short as possible to minimize ground loops.

## SMARTPAX CONFIGURATION

In most cases, SMARTPAX is configured automatically from Dataton TRAX. You must, however, manually set the SMARTPAX port address to correspond to the device's address in TRAX.

If you are using the manual mode in TRAX, you will need to configure the SMARTPAX using its port, address and device buttons.

Please refer to the SMARTPAX product sheet and the TRAX handbook for more details.

## CUSTOM SMARTLINKS

If you need to control an AV device not supported by a standard smartlink, you can make a custom smartlink using PAX AUXILIARY CABLE (article no: 3450).

## Technical Description

RS232 SMARTLINK cables can be used to connect SMARTPAX to a number of serial controllable devices. If in doubt, contact your Dataton dealer for advice on which smartlinks to use with different devices, or consult the device database from within Dataton TRAX®.

RS232 SMARTLINK has a standard cable length of 1.6m (63"). If necessary, you can extend this with Dataton EXTENSION CABLE, article number 3451 (1m), 3452 (2m) or 3455 (5m).

Pin number at SMARTPAX end	Color code	Signal symbol	Pin number on D-sub 25 pin male
1	Brown	Busy<	20
2	Red	RxD<	2
3	Orange	RxGND	7
4	Yellow	TxD>	3
5	Green	Ready>	5,6
6			
7			
8	White	TxGND	7
9			
		Screen	



# PC SMARTLINK

Art. No. 3487A

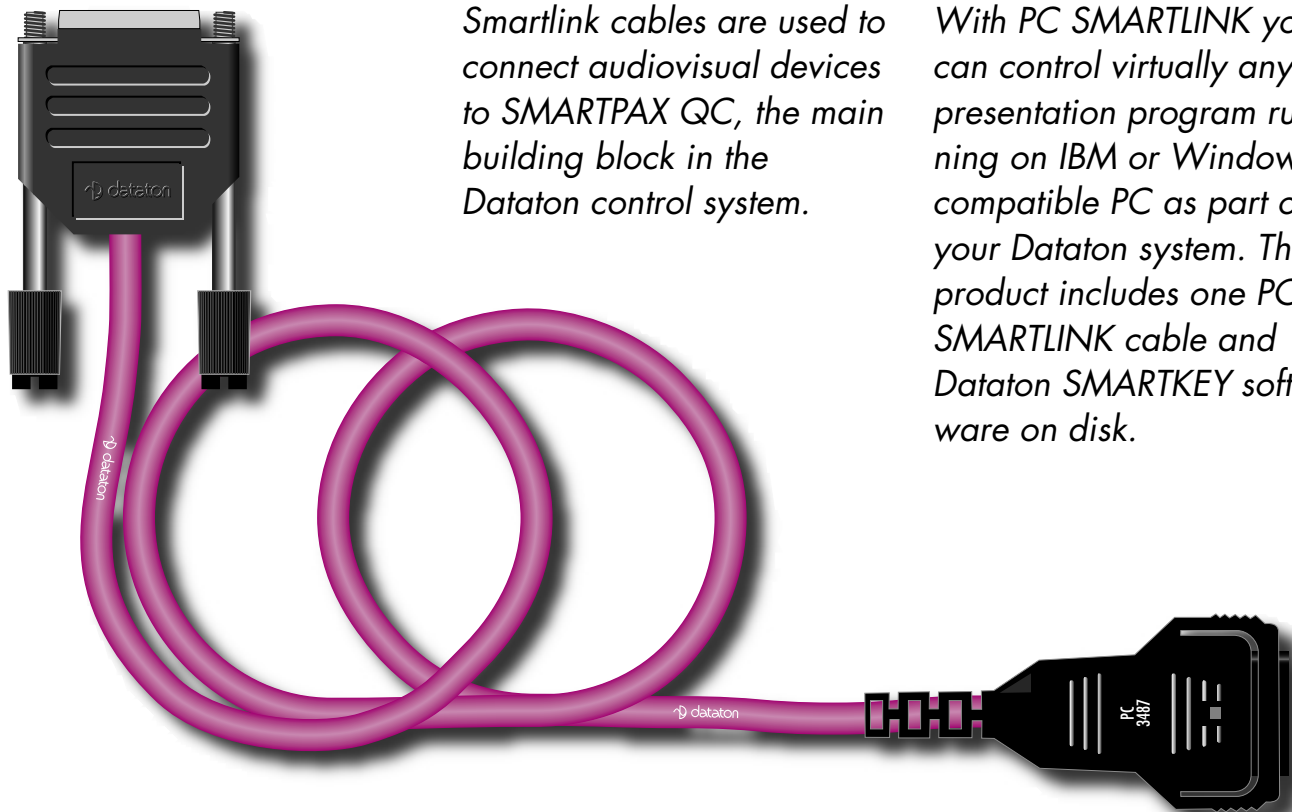

*Smartlink cables are used to connect audiovisual devices to SMARTPAX QC, the main building block in the Dataton control system.*

*With PC SMARTLINK you can control virtually any presentation program running on IBM or Windows compatible PC as part of your Dataton system. The product includes one PC SMARTLINK cable and Dataton SMARTKEY software on disk.*

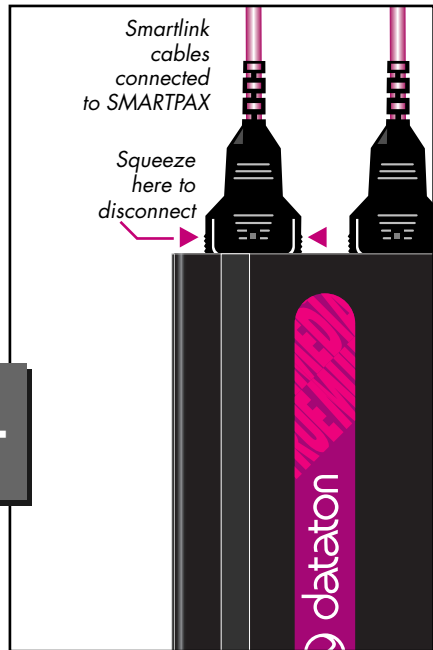

## USAGE

Connect the snap-lock connector to the back of a SMARTPAX, and the other end of the PC SMARTLINK to a COM port on the computer you want to control. Power up the SMARTPAX. Insert the PC ADAPTOR SOFTWARE disk into computer's drive A. Select drive A by typing "A:" and press Enter, then type "INSTALL". The installation program will guide you from here.

The SMARTKEY program constitutes the software part of the adaptor, enabling SMARTPAX to talk to your presentation program. There are two versions of this program, one for DOS-based presentation programs (SMARTKEY) and one for programs running under Microsoft Windows (SKWIN). The installation program will copy them onto your hard-disk as required. Choose the corresponding version of the program, and start it by typing its name followed by the number of the COM port used:

### SMARTKEY 1

Start the presentation program. If you're using Windows, first start Windows, then start SKWIN using the Windows Program Manager. You can supply the number of the COM port as a parameter to SKWIN.

Please refer to the SMARTPAX product sheet and the TRAX handbook for more details.

## IMPORTANT

Always connect the smartlink before turning on the power.

## Technical Description

The PC SMARTLINK package works by simulating the computer's keyboard through the serial port. This allows it to drive a presentation application in the same way as a user typing on the keyboard. The smartlink works with most popular presentation programs thanks to built-in software drivers in Dataton TRAX®. The PC SMARTLINK cable length is 1.6m (63") and may be extended with Dataton EXTENSION CABLE, article number 3451 (1m), 3452 (2m) or 3455 (5m).

Pin number at SMARTPAX end	Color code	Signal symbol	Pin number on D-sub 9 pin female
1	Brown	DTR	4
2	Red	TxD	3
3	Orange	Gnd	5
4	Yellow	RxD	2
5	Green	CTS, DSR	8, 6
6			
7			
8	Grey	Gnd	5
9		Screen	5

# TASCAM SMARTLINK

Art. No. 3483

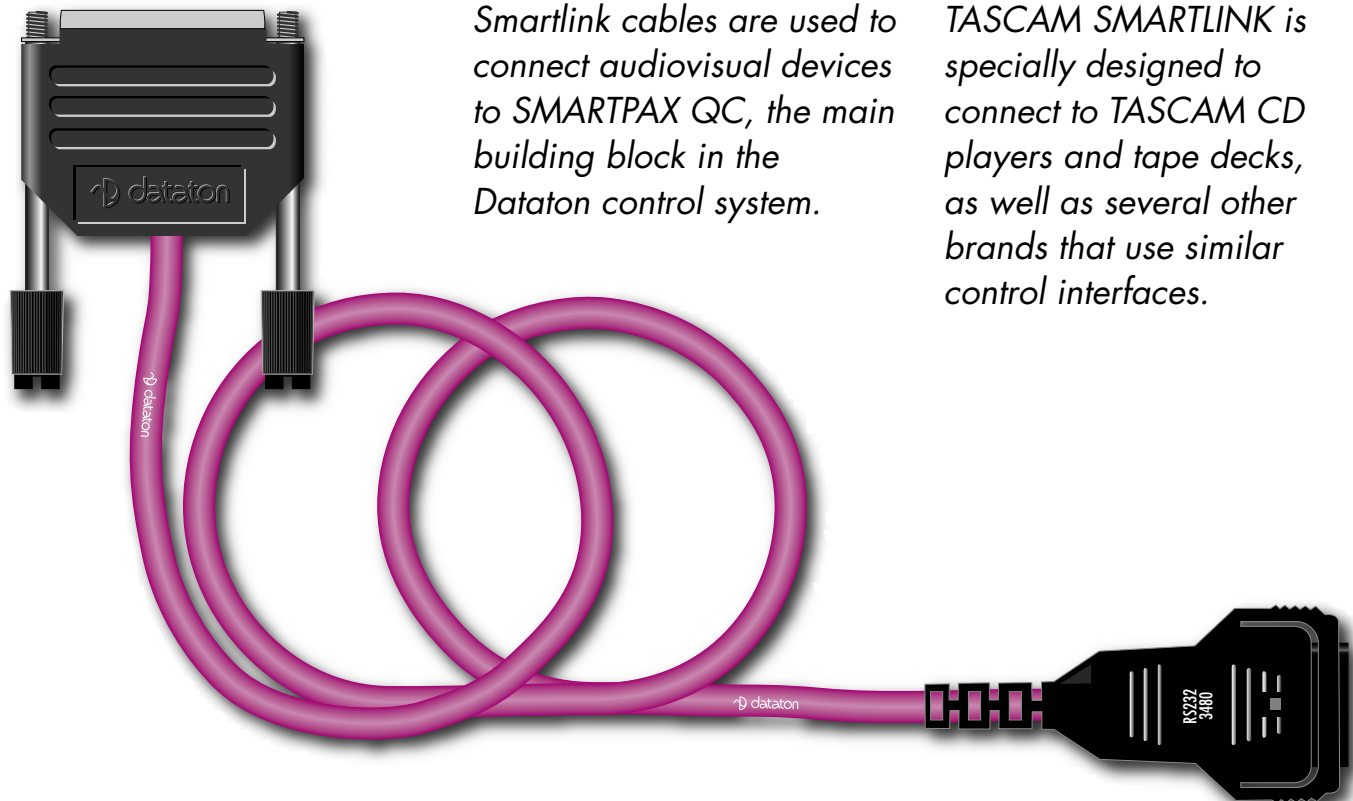

*Smartlink cables are used to connect audiovisual devices to SMARTPAX QC, the main building block in the Dataton control system.*

*TASCAM SMARTLINK is specially designed to connect to TASCAM CD players and tape decks, as well as several other brands that use similar control interfaces.*



## INSTALLATION

Always connect the smartlink to both the device and the SMARTPAX before turning on the power. Plugging or unplugging with the power on may cause damage to the equipment! Try to keep the cable between the SMARTPAX and the device as short as possible to minimize ground loops.

## SMARTPAX CONFIGURATION

In most cases, SMARTPAX is configured automatically from Dataton TRAX. You must, however, manually set the SMARTPAX port address to correspond to the device's address in TRAX.

If you are using the manual mode in TRAX, you will need to configure the SMARTPAX using its port, address and device buttons.

Please refer to the SMARTPAX product sheet and the TRAX handbook for more details.

## CUSTOM SMARTLINKS

If you need to control an AV device not supported by a standard smartlink, you can make a custom smartlink using PAX AUXILIARY CABLE (article no: 3450).

## Technical Description

TASCAM SMARTLINK cables can be used to connect SMARTPAX to a number of serial controllable devices. If in doubt, contact your Dataton dealer for advice on which smartlinks to use with different devices, or consult the device database from within Dataton TRAX®.

TASCAM SMARTLINK has a standard cable length of 1.6m (63"). If necessary, you can extend this with Dataton EXTENSION CABLE, article number 3451 (1m), 3452 (2m) or 3455 (5m).

Pin number at SMARTPAX end	Color code	Signal symbol	Pin number on D-sub 15-pin male
1	Brown	Busy<	
2	Red	RxD<	2
3	Orange	RxGND	8
4	Yellow	TxD>	4
5	Green	Ready>	
6			
7			
8	White	TxGND	8
9			
		Screen	

# PIONEER SMARTLINK

Art. No. 3486

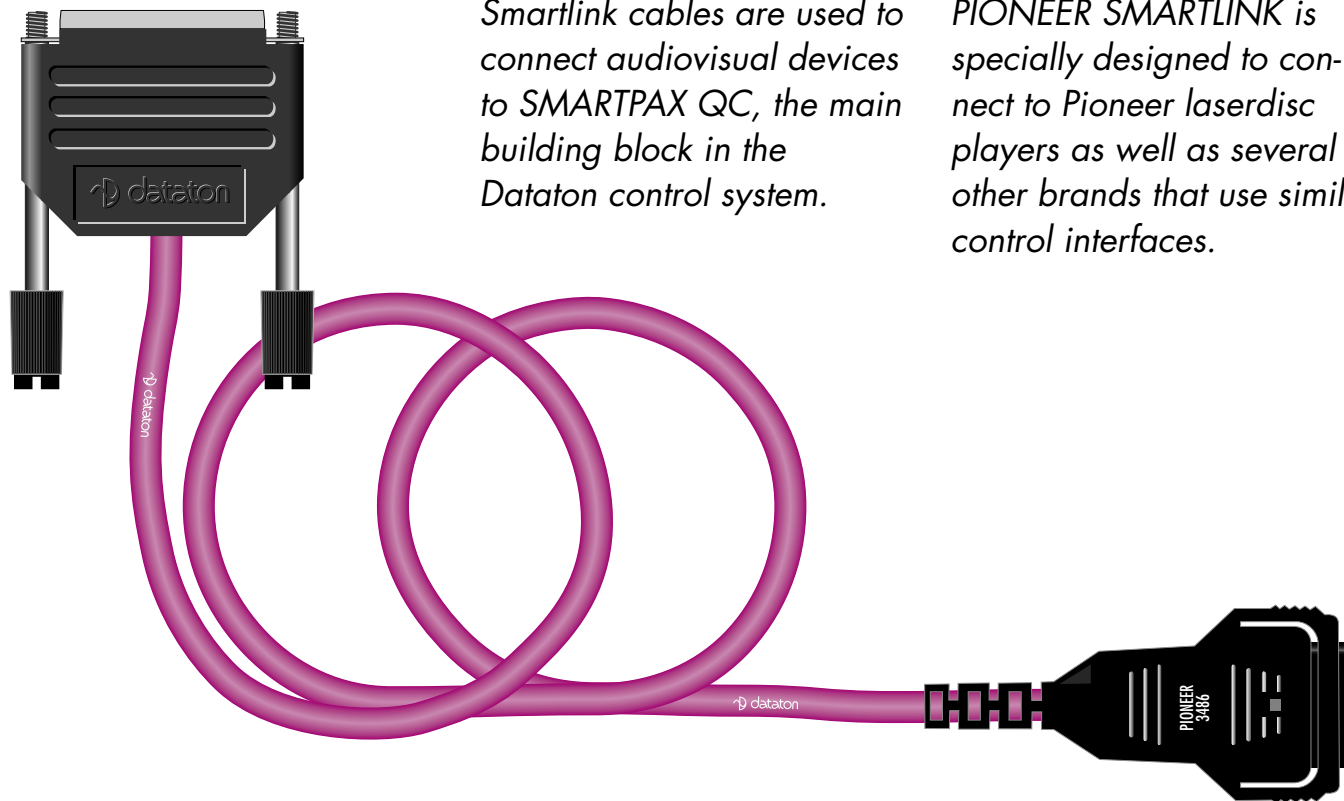

*Smartlink cables are used to connect audiovisual devices to SMARTPAX QC, the main building block in the Dataton control system.*

*PIONEER SMARTLINK is specially designed to connect to Pioneer laserdisc players as well as several other brands that use similar control interfaces.*

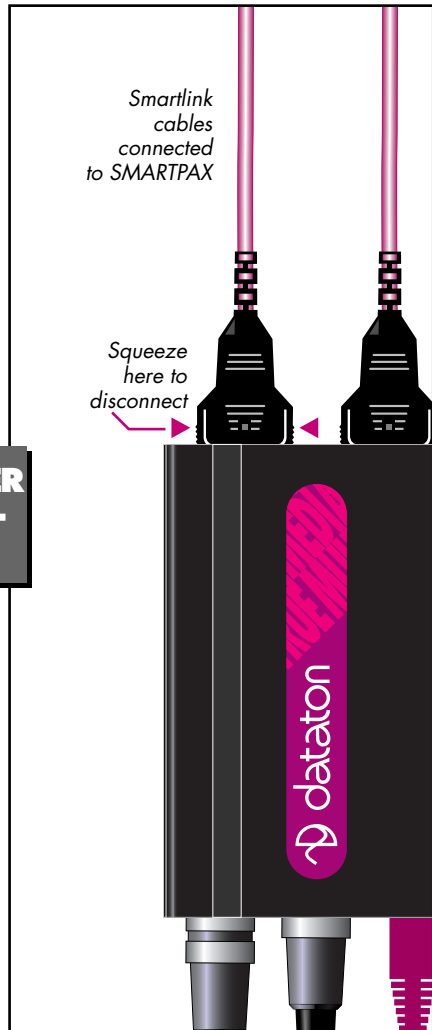

## INSTALLATION

Always connect the smartlink to both the device and the SMARTPAX before turning on the power. Plugging or unplugging with the power on may cause damage to the equipment! Try to keep the cable between the SMARTPAX and the device as short as possible to minimize ground loops.

## SMARTPAX CONFIGURATION

In most cases, SMARTPAX is configured automatically from Dataton TRAX. You must, however, manually set the SMARTPAX port address to correspond to the device's address in TRAX.

If you are using the manual mode in TRAX, you will need to configure the SMARTPAX using its port, address and device buttons.

Please refer to the SMARTPAX product sheet and the TRAX handbook for more details.

## CUSTOM SMARTLINKS

If you need to control an AV device not supported by a standard smartlink, you can make a custom smartlink using PAX AUXILIARY CABLE (article no: 3450).

## Technical Description

PIONEER SMARTLINK cables can be used to connect SMARTPAX to a number of serial controllable devices. If in doubt, contact your Dataton dealer for advice on which smartlinks to use with different devices, or consult the device database from within Dataton TRAX®.

PIONEER SMARTLINK has a standard cable length of 1.6m (63"). If necessary, you can extend this with Dataton EXTENSION CABLE, article number 3451 (1m), 3452 (2m) or 3455 (5m).

Pin number at SMARTPAX end	Color code	Signal symbol	Pin number on D-sub 15-pin male
1	Brown	Busy<	4
2	Red	RxD<	2
3	Orange	RxGND	1
4	Yellow	TxD>	3
5	Green	Ready>	
6			
7			
8	White	TxGND	1
9			
		Screen	

# RS422 SMARTLINK

Art. No. 3488

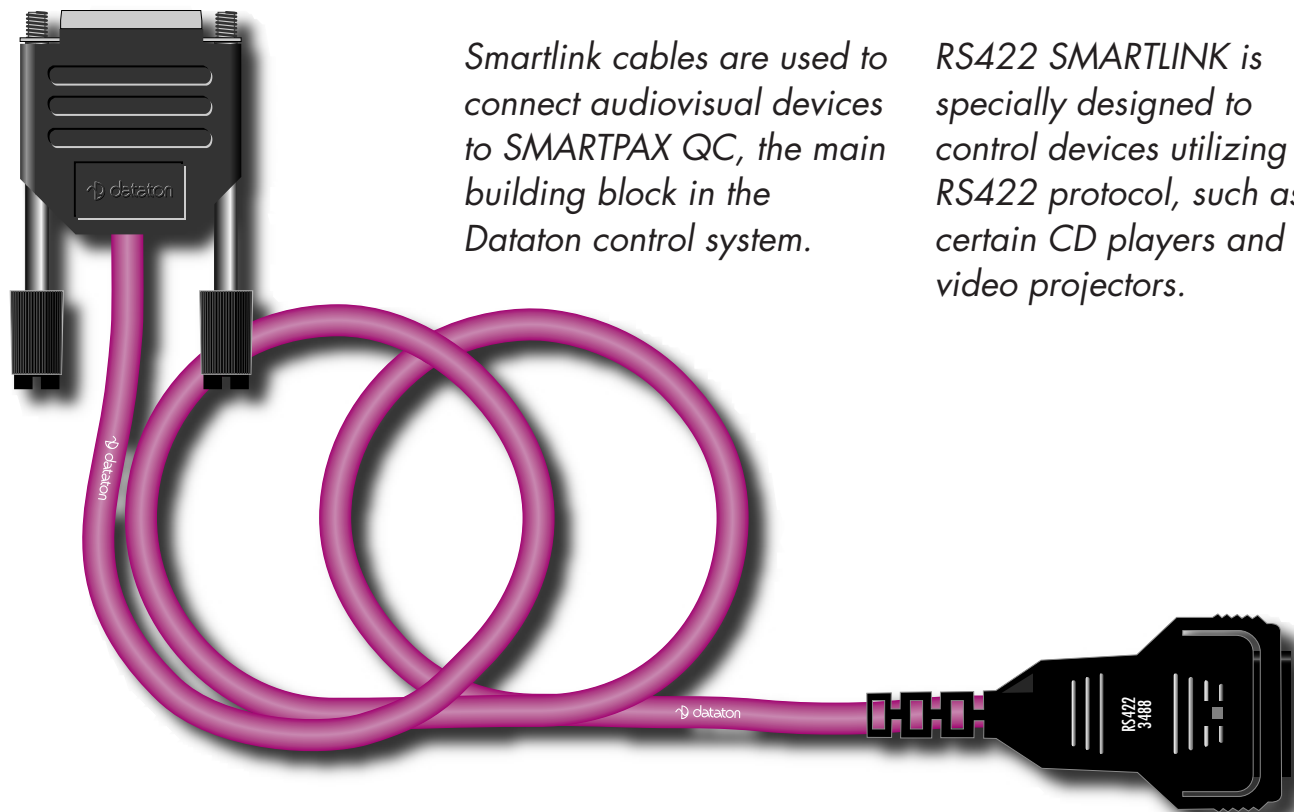

*Smartlink cables are used to connect audiovisual devices to SMARTPAX QC, the main building block in the Dataton control system.*

*RS422 SMARTLINK is specially designed to control devices utilizing RS422 protocol, such as certain CD players and video projectors.*

**RS422  
SMART-  
LINK**

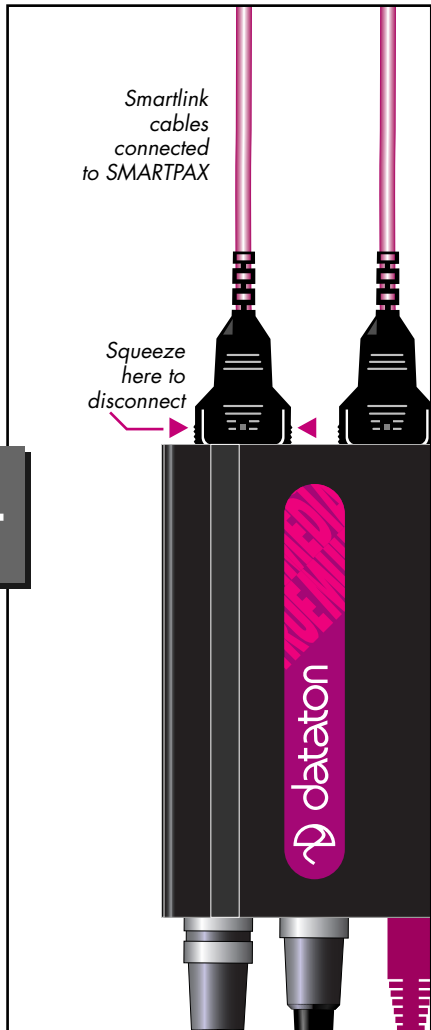

## INSTALLATION

Always connect the smartlink to both the device and the SMARTPAX before turning on the power. Plugging or unplugging with the power on may cause damage to the equipment! Try to keep the cable between the SMARTPAX and the device as short as possible to minimize ground loops.

## SMARTPAX CONFIGURATION

In most cases, SMARTPAX is configured automatically from Dataton TRAX. You must, however, manually set the SMARTPAX port address to correspond to the device's address in TRAX.

If you are using the manual mode in TRAX, you will need to configure the SMARTPAX using its port, address and device buttons.

Please refer to the SMARTPAX product sheet and the TRAX handbook for more details.

## CUSTOM SMARTLINKS

If you need to control an AV device not supported by a standard smartlink, you can make a custom smartlink using PAX AUXILIARY CABLE (article no: 3450).

## Technical Description

RS422 SMARTLINK cables can be used to connect SMARTPAX to a number of serial controllable devices. If in doubt, contact your Dataton dealer for advice on which smartlinks to use with different devices, or consult the device database from within Dataton TRAX®.

RS422 SMARTLINK has a standard cable length of 1.6m (63"). If necessary, you can extend this with Dataton EXTENSION CABLE, article number 3451 (1m), 3452 (2m) or 3455 (5m).

Pin number at SMARTPAX end  
Color code  
Signal symbol  
Pin number on D-sub 9 pin male

1	Brown	Busy<	
2	Red	RxD<	2
3	Orange	RxGND	7
4	Yellow	TxD>	8
5	Green	Ready>	
6			
7			
8	White	TxGND	3, 4
9			
		Screen	



# EKTAPRO SMARTLINK

Art. No. 3475

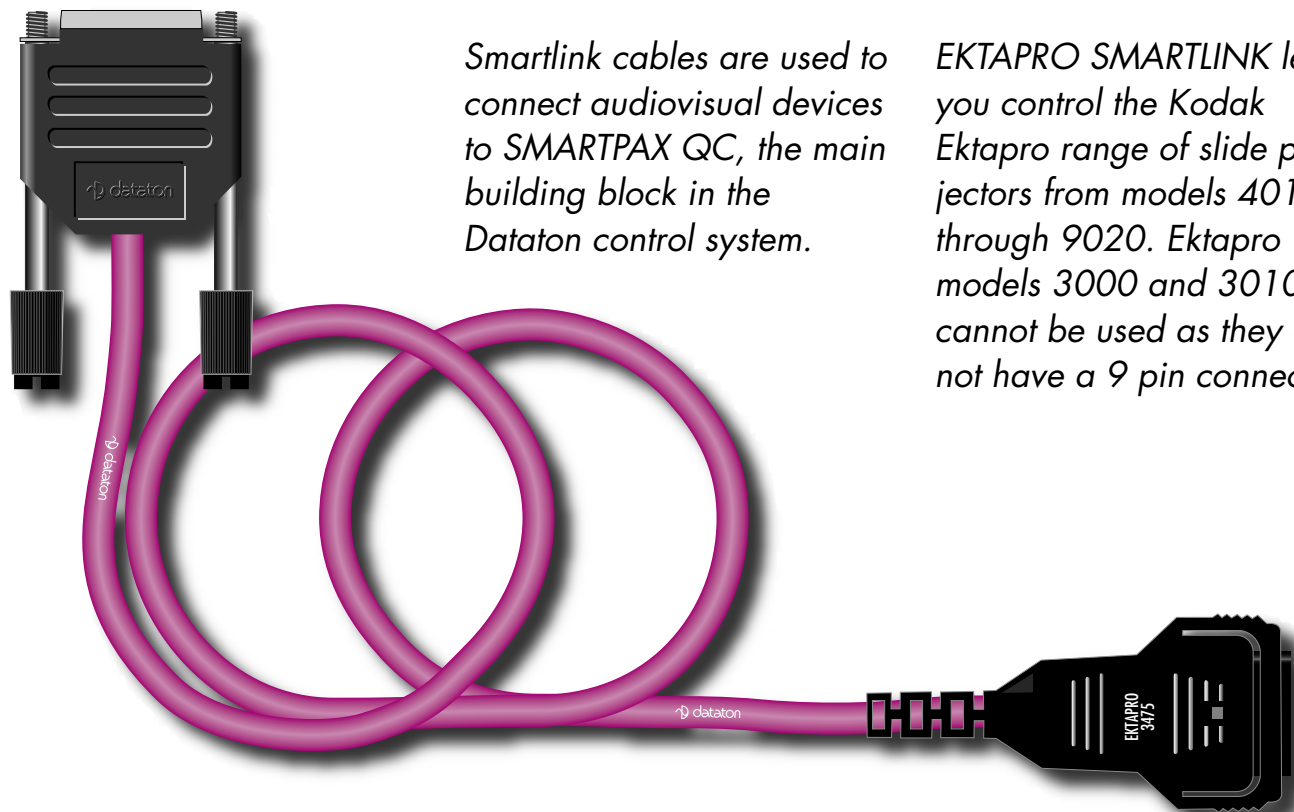

*Smartlink cables are used to connect audiovisual devices to SMARTPAX QC, the main building block in the Dataton control system.*

*EKTAPRO SMARTLINK lets you control the Kodak Ektapro range of slide projectors from models 4010 through 9020. Ektapro models 3000 and 3010 cannot be used as they do not have a 9 pin connector.*

## INSTALLATION

Plug the snap-lock connector into one of the four ports on the back of the SMARTPAX QC. Plug the other end of the cable into the *P-Bus In* connector on the projector. Set the projector's address selector at zero (this does not apply to models 4010 and 5000).

Always connect the smartlink before turning on the power. Plugging or unplugging with power on may cause damage.

### EKTAPRO SMARTLINK

Connect all projectors that are controlled from one SMARTPAX QC to the same mains outlet to avoid ground loop problems. Projectors controlled from different units may be powered from different mains outlets.

## CONFIGURATION

In most cases, SMARTPAX is configured automatically from Dataton TRAX. You must, however, manually set the SMARTPAX port address to correspond to the projector's address in TRAX.

If you are using the manual mode in TRAX, you will need to configure the

SMARTPAX QC using its port, address and device buttons.

Please refer to the SMARTPAX QC product sheet and the TRAX handbook for more details.

## PROGRAMMING

You can use all slide projector cues for programming Ektapro projectors, just as you would do with any other slide projector. The random access feature speeds up programming, and provides a way to re-use slides without the need for duplicates.

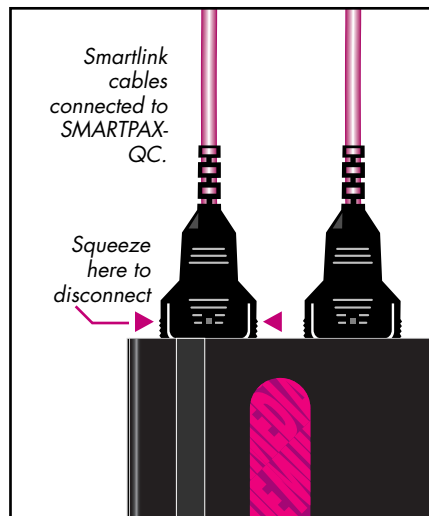

## Technical Description

EKTAPRO SMARTLINK connects Kodak Ektapro projector models 4010 to 9020 to SMARTPAX QC. It uses the P-Com serial data language to control the projector, which supports advanced features such as slide random access. The projectors are programmed from Dataton TRAX®.

The EKTAPRO SMARTLINK cable is 1.6m (63") long and may be extended with EXTENSION CABLE, article no: 3451 (1m), 3452 (2m) or 3455 (5m).

Pin number of SMARTPAX end  
Color code  
Signal symbol  
Pin number of Ektapro end

1			
2	Red	TxD	2
3	Orange	GND	1,5
4	Yellow	RxD	3
5			
6			
7			
8	White	GND	1,5
9			
		Screen	1,5

# MAC SMARTLINK

Art. No. 3457

*Use MAC SMARTLINK to control presentation graphics programs running on Apple Macintosh computers as part of your multimedia rig.*

*Connect the smartlink between the Macintosh and Dataton SMARTPAX, then program functions from Dataton TRAX software.*

*The MAC SMARTLINK package contains two cables: a standard control cable and a Mac adaptor.*

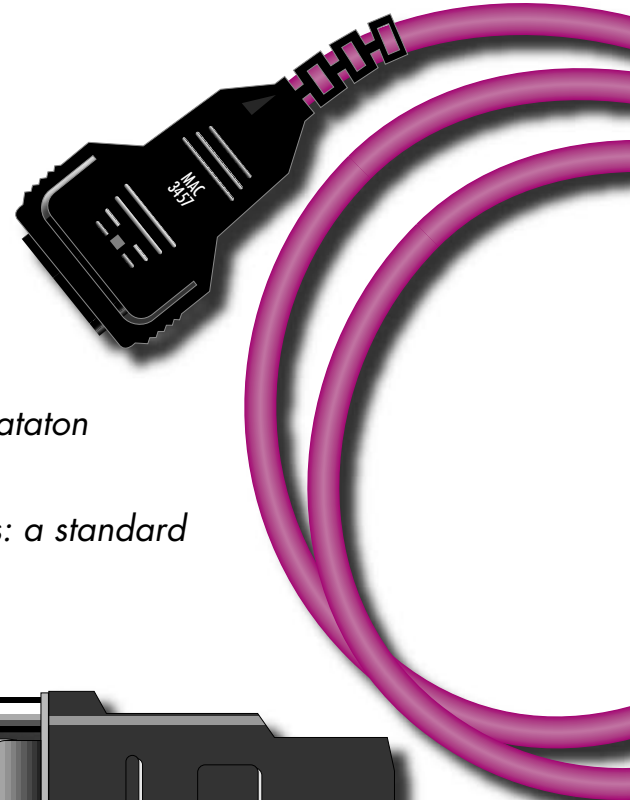
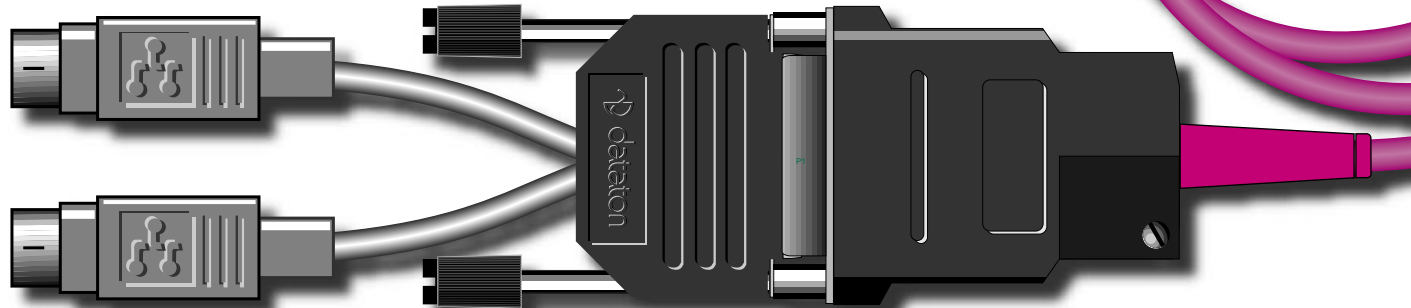

## USAGE

Assemble MAC SMARTLINK by putting the Mac adaptor and the VERSAPLUS cable together using the 15 pin connector. Make sure you tighten the locking screws on the connector before use.

The Mac adaptor part of the smartlink includes two leads: one has a male connector and the other a female connector. Plug the lead with the male connector into the ADB port (⌘) of the Macintosh you wish to control. If you only have one ADB port on your Mac and want to use both MAC SMARTLINK and your keyboard, plug in the male connector as above and plug the female connector into your keyboard via a male-to-male ADB lead. The snap-lock connector at the other end of the smartlink plugs into one of the four ports on the back of SMARTPAX.

Set the SMARTPAX port address to correspond to the device's address in TRAX. For details on how to program applications using MAC SMARTLINK, please refer to the device information database inside Dataton TRAX.

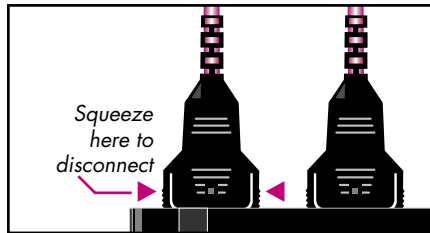

## IMPORTANT

Some Macintosh computers in the PowerBook range do not have an ADB port (⌘). These models cannot be used with MAC SMARTLINK.

Remember to check that the VERSAPLUS cable and the Mac adaptor are properly connected before using the smartlink.

Always connect the smartlink to the ADB port before turning on the power to the Mac. Plugging or unplugging the smartlink while the computer is on may cause damage to the smartlink and/or your Mac. To avoid ground loop problems related to the ADB bus, connect all devices used with the same SMARTPAX to the same power outlet.

## Technical Description

MAC SMARTLINK connects SMARTPAX to Apple Macintosh computers, thus incorporating them into your Dataton TRAX® rig.

The smartlink works by simulating the Mac's keyboard. That means that you can drive virtually any Mac application in the same way as a user typing on the keyboard. The difference is that you can do it from a distance, integrating it in your main presentation.

MAC SMARTLINK consists of a VERSAPLUS cable and a Mac adaptor (labeled 3457). The VERSAPLUS cable has its own microprocessor which is housed in the 15 pin D-sub connector. The microprocessor transforms the RS232 serial data that is output by SMARTPAX into the synchronous common in/out TTL data used by the ADB port on the Mac.

The smartlink cable length is 1.6m (63") and may be extended with Dataton EXTENSION CABLE, article number 3451 (1m), 3452 (2m) or 3455 (5m).

# IR SMARTLINK

Art. No. 3453

*Use IR SMARTLINK to control infrared-driven devices such as CD players, video projectors, TV sets, dedicated presentation devices.*

*Position one end of the smartlink over the device's infrared detector and plug the other end into Dataton SMARTPAX, then program functions from Dataton TRAX® software.*

*The IR SMARTLINK package contains a standard control cable and an IR adaptor.*





## USAGE

First of all, assemble IR SMARTLINK by putting the IR adaptor and the VERSAPLUS cable together with the 15 pin connector. Always tighten the locking screws on the connector before use. Peel off the protective covering on the free end of the IR adaptor. Carefully center the self-adhesive ring over the device's infrared eye. Spare adhesive rings are included with the smartlink.

Plug the snap-lock connector into one of the four ports on the back of Dataton SMARTPAX and set the SMARTPAX port address to correspond to the device's address in TRAX. For more information on programming applications using IR SMARTLINK, refer to the TRAX handbook and device information database.

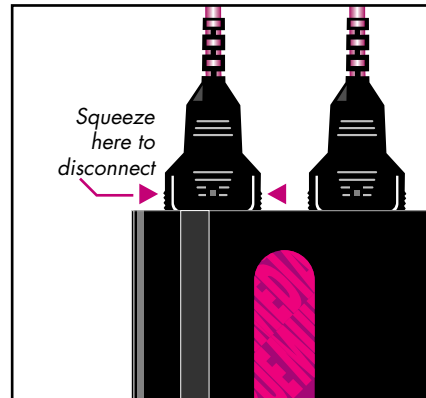

## Technical Description

IR SMARTLINK connects SMARTPAX to devices normally controlled by an infrared remote unit.

Two cables form IR SMARTLINK: the VERSAPLUS cable and the IR adaptor (labeled 3453). The VERSAPLUS cable has its own microprocessor which is housed in the 15 pin D-sub connector. The microprocessor transforms the RS232 serial data that is output by SMARTPAX into the pulse-code modulated IR data used by the device to be controlled.

The smartlink cable length is 1.6m (63") and may be extended with Dataton EXTENSION CABLE article number 3451 (1m), 3452 (2m) or 3455 (5m).

# DMX SMARTLINK

Art. No. 3456

*Use DMX SMARTLINK to control lighting devices utilizing the DMX 512 control protocol.*

*Connect the smartlink between the DMX device and Dataton SMARTPAX, then program functions from Dataton TRAX® software.*

*The DMX SMARTLINK package contains a standard control cable and a DMX adaptor.*

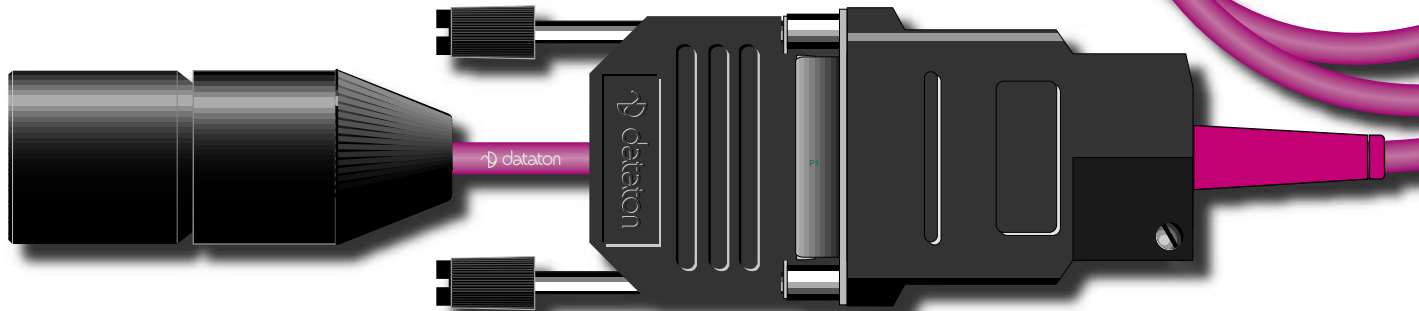





## USAGE

First of all, assemble DMX SMARTLINK by putting the DMX adaptor and the VERSAPLUS cable together using the 15 pin connector. Always tighten the locking screws on the connector before use. Plug the free end of the DMX adaptor into the DMX port of the device you want to control. Plug the snap-lock connector at the other end of the smartlink into one of the four ports on the back of SMARTPAX. Set the SMARTPAX port address to correspond to the device's address in TRAX.

For details on how to program applications using DMX SMARTLINK, please refer to the device information database inside Dataton TRAX.

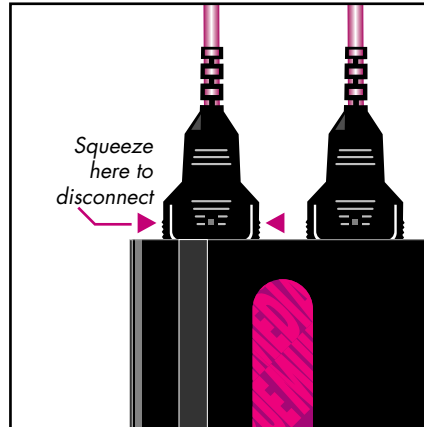

## Technical Description

DMX SMARTLINK connects SMARTPAX to various lighting devices that use the DMX 512 protocol.

Two cables form DMX SMARTLINK: the VERSAPLUS cable and the DMX adaptor (labeled 3456).

The VERSAPLUS cable (used for several non-RS232 serial protocols) has its own microprocessor housed in a 15 pin D-sub connector. This transforms the low-speed RS232 serial data that is output by SMARTPAX into high-speed RS485 serial data as used by the DMX 512 protocol.

The smartlink cable length is 1.6m (63") and may be extended with Dataton EXTENSION CABLE, article number 3451 (1m), 3452 (2m) or 3455 (5m).

## Important

Please note that it is only possible to control 32 channels of DMX 512 from a single SMARTPAX port. If more than 32 channels are required, then you must use another DMX SMARTLINK and another free port on the SMARTPAX.



# TIMECODE SMARTLINK

Art. No. 3454

*Use TIMECODE SMARTLINK to control analog tape devices and SMPTE/EBU timecode-controlled devices as part of your Dataton multimedia rig.*

*Connect the smartlink between Dataton SMARTPAX QC and the device, then program it from Dataton TRAX® software.*

*The TIMECODE SMARTLINK package contains a standard control cable and a tape adaptor.*

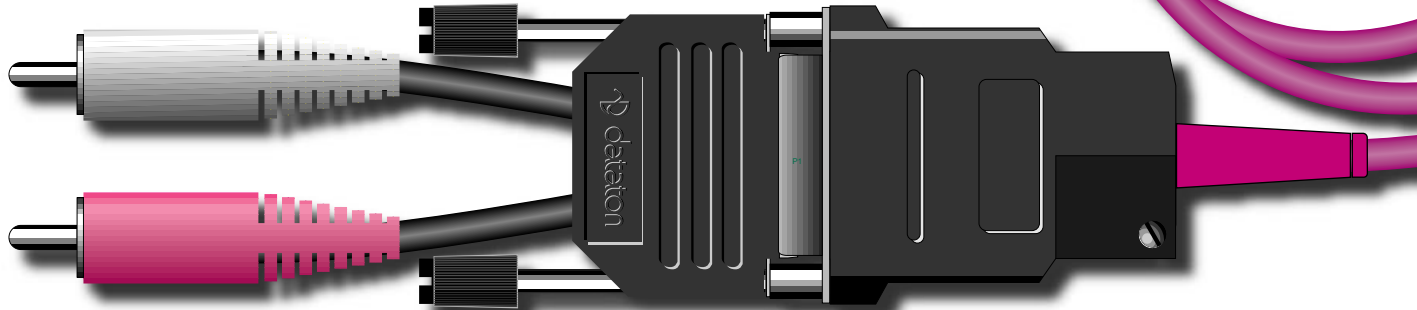



## USAGE

First of all, assemble TIMECODE SMARTLINK, by putting the tape adaptor and the VERSAPLUS cable together using the 15 pin connector. Always tighten the locking screws on the connector before use.

Plug the red phono connector into the timecode input port on the device you want to control. Plug the white phono connector into the timecode output port on the device from which you want to read timecode. Plug the snap-lock connector at the other end of the smartlink into one of the four ports on the back of SMARTPAX QC. For details on how to program applications using TIMECODE SMARTLINK, please refer to the TRAX handbook.

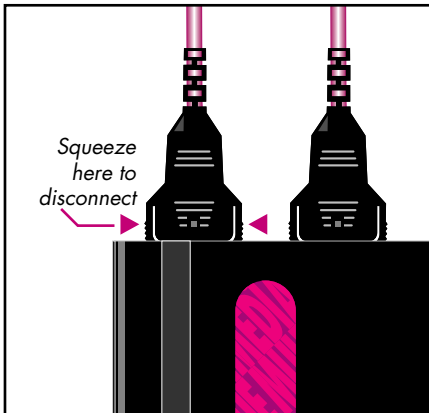

## Technical Description

TIMECODE SMARTLINK connects SMARTPAX to analog tape and SMPTE/EBU timecode controlled devices, thus incorporating them into your Dataton TRAX rig.

Two cables form TIMECODE SMARTLINK: the VERSAPLUS cable and the tape adaptor (labeled 3458).

The VERSAPLUS cable has its own microprocessor housed in the 15 pin D-sub connector. The microprocessor handles the transformation of the RS232 serial data output by SMARTPAX into the analog frequency domain data used for timecode recording and reading.

The red phono connector on the tape adaptor outputs data to the device to be controlled. The white phono connector reads frequency shifted data like SMPTE/EBU timecodes.

The smartlink cable length is 1.6m (63") and may be extended with Dataton EXTENSION CABLE, article number 3451 (1m), 3452 (2m) or 3455 (5m).

# SYSTEM CABLE KIT

Art. No. 3420

*In the Dataton system, control signals are transmitted between units through a bus system of optically isolated electronic parts inside each control unit and high quality SYSTEM CABLE.*

*Dataton SYSTEM CABLE is available in standard lengths of 0.4m, 1m, 2m and 5m. If you need a different length cable, you can use the SYSTEM CABLE KIT to make your own.*

*Each SYSTEM CABLE KIT contains 100m of high quality, non-PVC cable and 10 pairs of connectors.*

## USAGE

The SYSTEM CABLE KIT consists of 100m of cable and 10 pairs of connectors.

To use the kit, first cut the cable to the required length. Strip about 20mm (3/4") of the outer covering off either end of the cable using a sharp knife or cable stripper. Take care not to cut too deeply! Unwind the screen and twist it. Dismantle each of the six wires about 3mm (1/8"), and then twist the strands.

Put the connector shells onto the cable. Solder the strands and the screen according to the illustration below and the pin number markings inside each connector. The screen must be soldered to the solder tab in the connector's housing.

Mount the cable grip upside down. This secures the cable mechanically. Tighten the screws firmly, but not too hard.

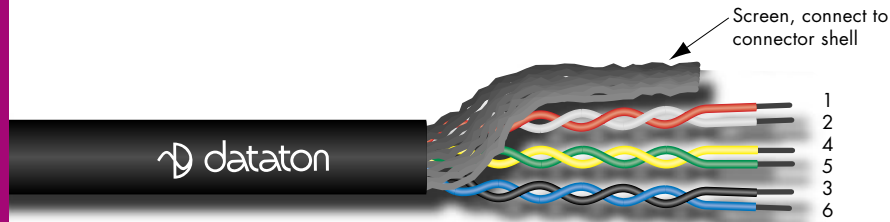

## IMPORTANT

*SYSTEM CABLE is used to supply power to MIC3+ and AIRLINK RECEIVER so the maximum length when connected to any of these units is 25m. SYSTEM CABLE may also, on occasion, be used to supply power to TRANSPAX+ or MICTOUCH. The maximum cable length is then 25m.*

*In all other cases, up to 100m of SYSTEM CABLE can be used between units.*

## Technical Description

The Dataton control system works on a daisy-chain principle with control units linked by SYSTEM CABLE. SYSTEM CABLE carries cue data from one control unit to the next. It runs from the first control unit's OUT connector to the second unit's IN connector, and so on.

The cable itself consists of a screen and three twisted wire pairs. One of the twisted pairs carries cue data from the data source to the control units; one is used for data feedback from control units; and one is used to handle power distribution.

The insulating material used in the cable is non-PVC and flame retardant. It is extremely resistant to mechanical and thermal stress.

The outer diameter of the cable is 4.5mm–5.0mm (0.175–0.2") and the outer cable jacket is black. The wire gauge is AWG 24.

The 6 pin female connector plugs into the control unit's **DATA IN** port. The 6 pin male connector plugs into the **DATA OUT** port.

# AUXILIARY CABLE

Art. No. 3450

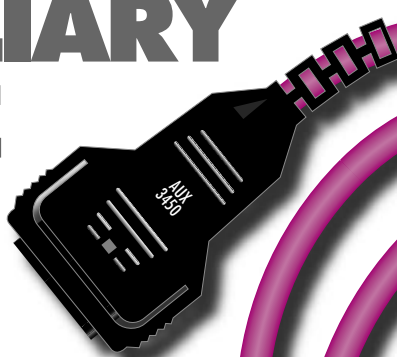

*AUXILIARY CABLE should be used whenever you intend to connect a device to SMART-PAX, PAX or TRANSPAX for which a standard Dataton cable is not available, for example, various relays and switches as well as audio and video routers.*

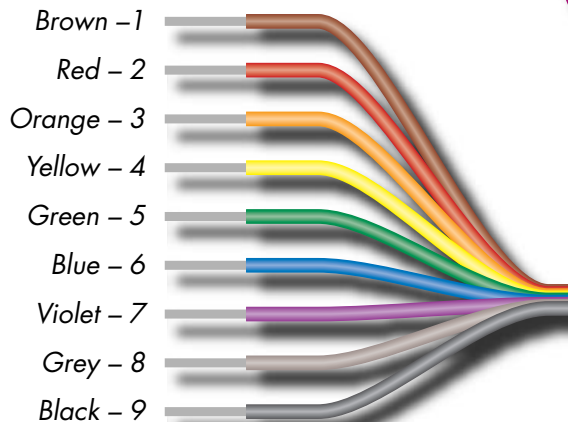

## WITH SMARTPAX

If you need to connect a device to SMARTPAX for controlling or sensing purposes and there is no standard smartlink available, use AUXILIARY CABLE. The SMARTPAX pin-out and functions are shown below.

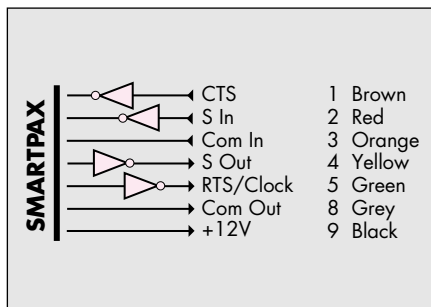

## WITH PAX

With PAX you have access to two relays, designated W Aux and Y Aux. These can handle 24V 1A. If AUXILIARY CABLE is used to connect these relays to external power relays or other inductive loads, the included varistors must be connected in parallel with the W Aux and Y Aux relays.

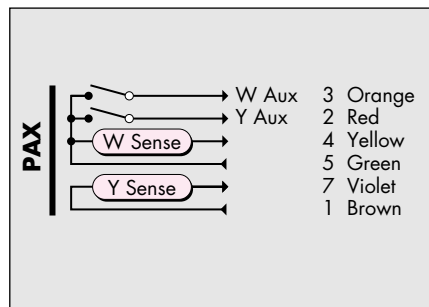

## WITH TRANSPAX

The **TAPE** connector on TRANSPAX may be used for controlling most analog, open-reel tape recorders. If no suitable standard cable is available, use AUXILIARY CABLE. TRANSPAX pin-out and functions are shown below.

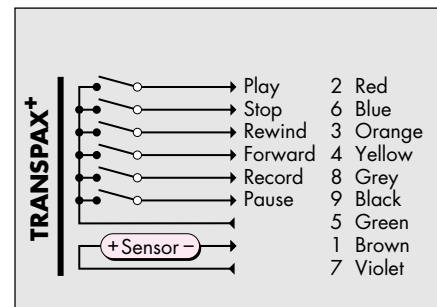

### NOTE

**If you are not sure how to make the connection, get in touch with your Dataton dealer or the Dataton support team at e-mail: [support@dataton.se](mailto:support@dataton.se) for more information.**

# TRAX CABLE

Art. No. 3425

The TRAX CABLE is used to connect the computer running Dataton TRAX® to the first control unit in the rig. The cable plugs into the serial port of the computer and the IN port on the front of the Dataton control unit. To double the capacity of your system, you can use two cables, one connected to each serial port on your computer.

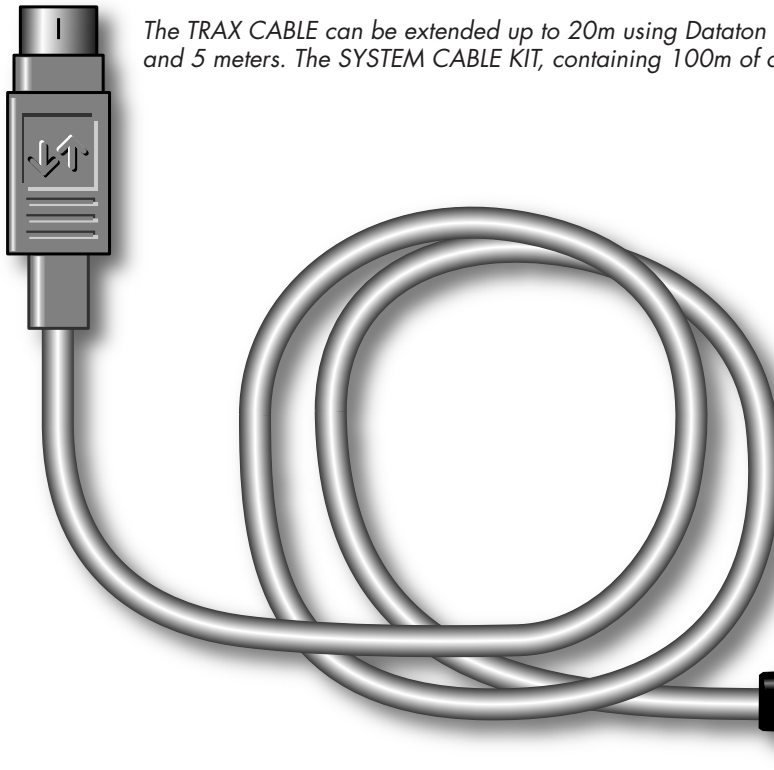

The TRAX CABLE can be extended up to 20m using Dataton SYSTEM CABLE sold in standard lengths of 0.4, 1, 2, and 5 meters. The SYSTEM CABLE KIT, containing 100m of cable for custom installations, is also available.

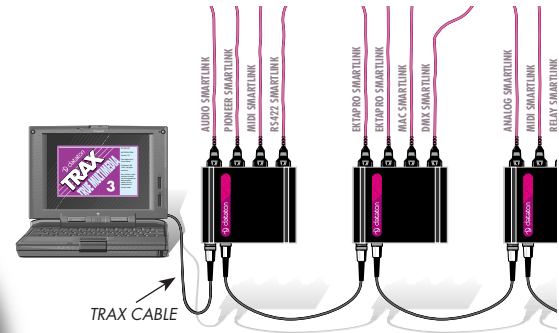

If you are using an Apple computer without a serial port (eg, iMac, G3 or G4 computers), you will need a USB to serial adapter. You'll find information on suitable adapters on Dataton's website: [www.dataton.com](http://www.dataton.com), listed under Dataton TRAX in the Product Info section.

# PC CABLE

Art. No. 3429



The PC CABLE is used together with Dataton SMARTSCRIPT software for PCs. The cable connects the computer running Dataton SMARTSCRIPT to the first Dataton SMARTPAX QC control unit in the rig. The cable plugs into the *com* port of the computer and the *IN* port on the front of the Dataton SMARTPAX QC. Remember to power SMARTPAX QC with the appropriate power supply unit. For more information, please refer to the SMARTPAX QC product sheet.

The PC CABLE can be extended up to 20m using Dataton SYSTEM CABLE which is sold in standard lengths of 0.4, 1, 2, and 5 meters. The SYSTEM CABLE KIT, containing 100m of cable for customized installation, is also available from Dataton.

If you are programming from an Apple Macintosh computer, please use the TRAX CABLE (article number 3425) instead.

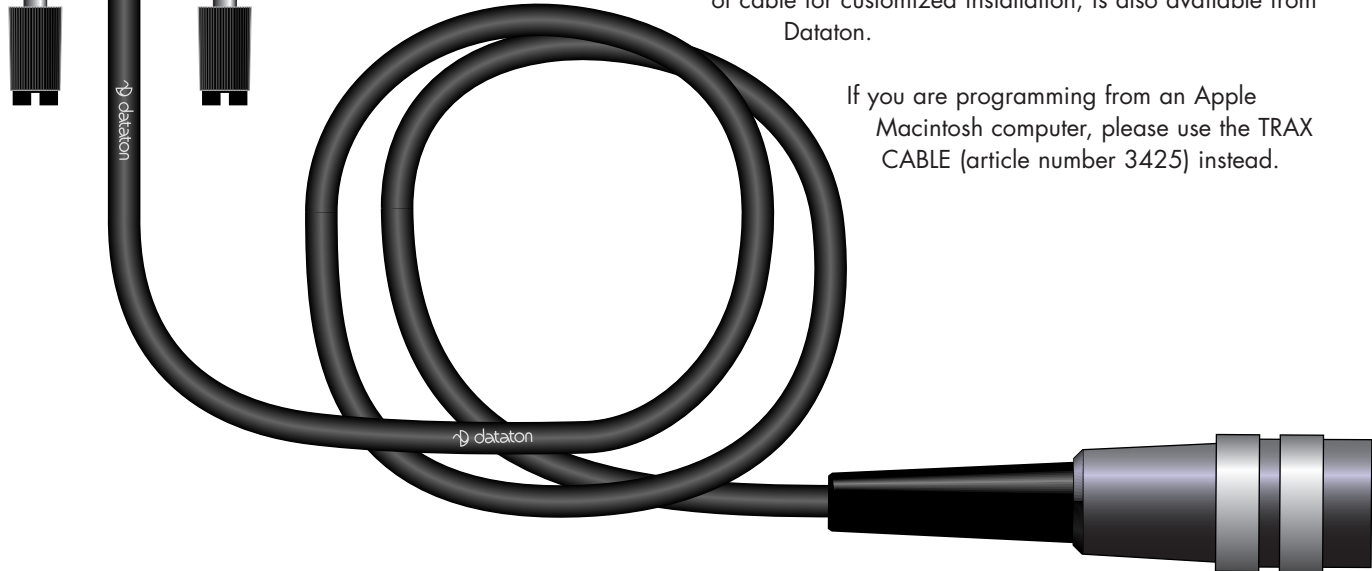



# KEYLINK

Art. No. 3498

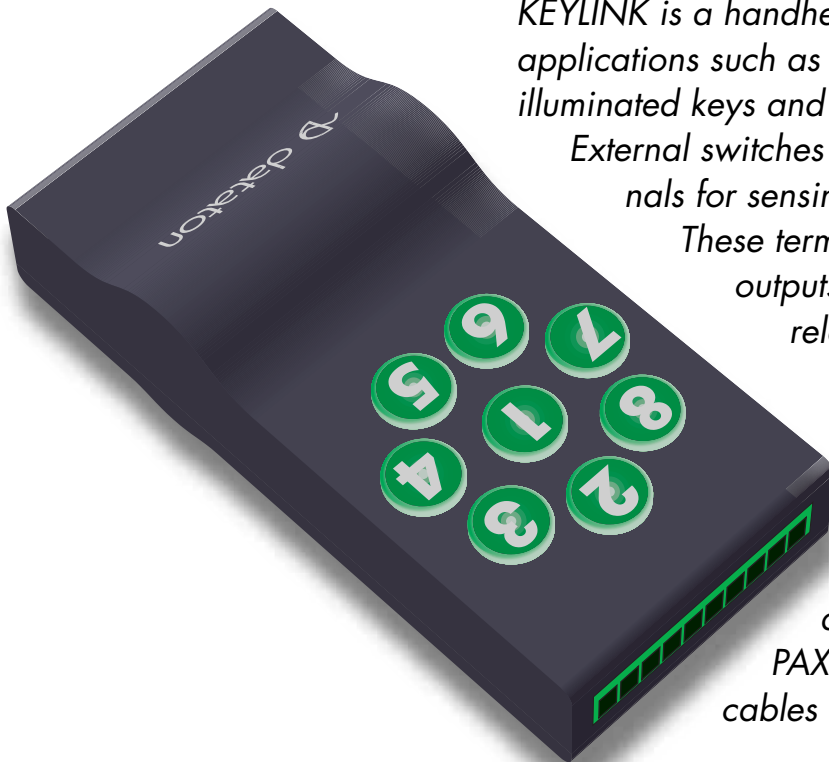

*KEYLINK is a handheld keypad for use in remote control applications such as conference rooms. It features eight illuminated keys and eight screw connector terminals.*

*External switches may be connected to these terminals for sensing input such as a door opening.*

*These terminals can also be used as low-level outputs for activating external power relays. The internal keys are connected in parallel with the screw terminal connections.*

*KEYLINK fits into the Dataton control system via SMARTPAX QC. Four KEYLINK units may be daisy-chained to a single SMARTPAX QC port using the connection cables shipped with each KEYLINK unit.*

## USAGE

KEYLINK is a versatile eight channel digital IN/OUT unit which can be used as a handheld keypad transferring key closures from its built-in keys to the Dataton control system. Alternatively, external switches may be used, connected in parallel with the internal keys. Such switches are connected via the 10-pole screw terminal, where two poles are reserved for the common connections (ground) and the remaining eight (labeled 1-8) for the corresponding keys.

C C 1 2 3 4 5 6 7 8

The screw terminal label.

The screw terminal channels also double as digital outputs. When "ON", these outputs make a low impedance connection with the common poles. When

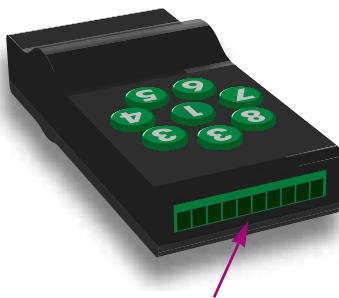

The screw terminal jack.

"OFF", they are pulled to an internal 12V DC source via 1.5 K $\Omega$  resistors.

The screw terminal poles may be turned to "ON" as a result of key pressure on the KEYLINK unit itself or as a result of a programmed action from Dataton TRAX. In both cases, the corresponding key's LED is lit.

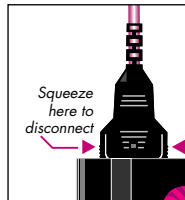

KEYLINK is used with the SMARTPAX QC control unit in the Dataton system. To connect KEYLINK to a SMARTPAX QC,

use the enclosed cable, 3443 SMARTBRANCH FIRST CABLE. The snaplock connector plugs into a SMARTPAX QC port and the modular connector goes to the IN port on the KEYLINK. To identify the KEYLINK unit's IN port, look for the single green diode at the base of the unit. The IN port is the one placed closest to this green LED.



## CONNECT MORE UNITS

To connect additional units on the same SMARTPAX port, use the enclosed modular to modular cable, 3444 SMARTBRANCH LINK CABLE. This should go from the OUT port of the first KEYLINK to the IN connector on the second unit. In this way, you can run up to four KEYLINK units from one SMARTPAX port.

You may mix POWERLINK and KEYLINK units on the same SMARTPAX port. The remaining ports may be used to control more POWERLINK or KEYLINK units, or unrelated media devices as required.

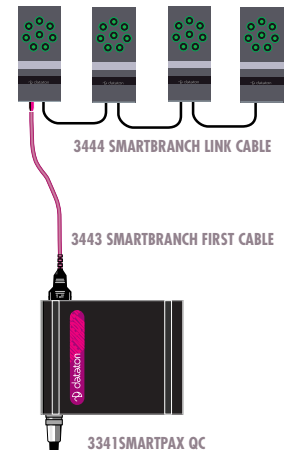

KEYLINK hook-up

## PROGRAMMING

KEYLINK functions are accessed and programmed from Dataton TRAX control software, version 3.6.1 or later. This software is available free of charge from Dataton's website: [www.dataton.com](http://www.dataton.com)

To program KEYLINK, create a Switch device in TRAX and select Dataton KEYLINK on the Type pop-up menu. The subaddress corresponds to the key/terminal number on the unit. Set the Function

as appropriate: Input for input function only, ie, the button on the unit, or an externally connected input; Output for output function only, ie, button illumination or other externally connected function; or Both.

If you are running multiple KEYLINK units on the same SMARTPAX QC port, use subsequent subaddresses for the additional inputs and outputs. For example,

use subaddress 9 for the first input/output on the second KEYLINK, and so on.

To program the button LEDs/outputs, use a Trigger cue set to On, Off, Pulse or Toggle and assigned to the switch device(s) to be controlled.



For detailed programming advice, always refer to the information database inside Dataton TRAX.

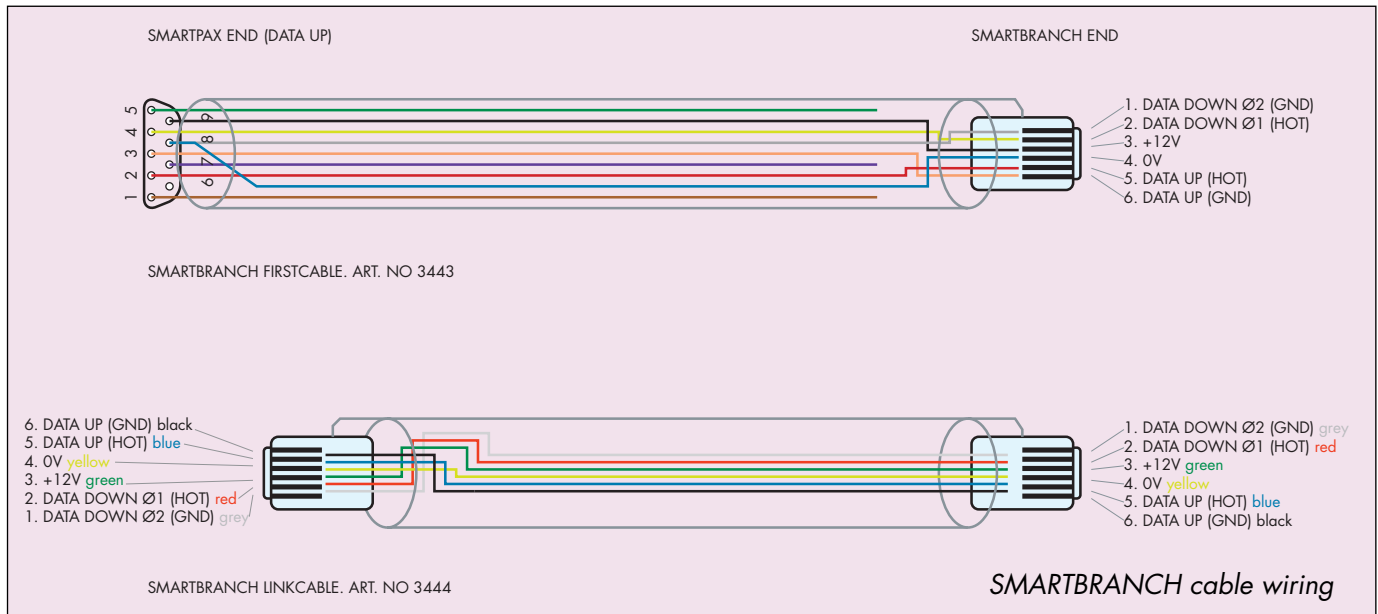

## Technical Description

Use with Dataton TRAX, version 3.6.1 or later, and Dataton SMARTPAX QC. Up to four KEYLINK units can be daisy-chained off one SMARTPAX QC port. POWERLINK and KEYLINK units can be freely mixed on one port.

KEYLINK has eight buttons with built-in light emitting diodes for feedback.

External buttons or other inputs/outputs can be connected through a detachable screw-terminal strip. Each I/O pin has an internal pull-up resistor of 1.5 k $\Omega$  to 12 V DC. To activate an input from the outside, close the I/O pin to ground (pin "C").

As a side effect, this turns on the LED in the corresponding key.

Each one of the internal keys is wired between the corresponding I/O pin and ground. Pressing one of the keys will, as a side effect, pull the corresponding I/O pins to ground.

When activating an output switch through programming, the button LED will light up and the corresponding I/O pin will be pulled to ground.

The output switch is a solid state switch with a resistance of approximately 0.5  $\Omega$ . As the input and output functions share the same pin, it is not possible to sense an input signal through the terminal strip if the key is pressed, or vice versa.

**IMPORTANT:** The I/O circuits are for DC voltage only. Do not connect any of the I/O pins to a negative voltage in respect to the common pin marked "C".

Connecting an I/O pin to a low-impedance voltage source higher than +50V or lower than -0.5V may permanently damage the KEYLINK.



KEYLINK, article number 3498  
 Size: 105×46×25mm (4.1"×1.8"×1.0")  
 Weight: 115g  
 Shipped with cables 3443 and 3444

# SYSTEM CABLE

Art. No. 3410  
0.4m (16")

Art. No. 3411  
1m (40")

Art. No. 3412  
2m (80")

Art. No. 3415  
5m (200")

SYSTEM CABLE is available in four standard lengths: 0.4, 1, 2, and 5 meters and is used to link Dataton units in a rig.

The cable itself consists of a screen and three twisted wire pairs. One of the twisted pairs carries cue data from the data source to the control units; one is used for data feedback from the control units; and one is used to handle power distribution.

The insulating material used in the cable is non-PVC and flame retardant. It is extremely resistant to mechanical and thermal stress.

## USAGE

SYSTEM CABLE carries cue data from one Dataton control unit to another. Plug SYSTEM CABLE into the **OUT** connector of the Dataton control unit closest to the data source (ie, the computer running TRAX). Plug the other end into the **IN** connector of the next control unit in the rig, and so on.

SYSTEM CABLE can also be used to distribute power between earlier Dataton control units, such as PAX, to AIRLINK RECEIVER. Power then travels along the SYSTEM CABLE from the supplier unit's **IN** connector to the receiver unit's **OUT** connector

## CUSTOMIZED CABLES

For fixed installations and other special requirements, you may need cables with tailor-made lengths. With the SYSTEM CABLE KIT (article number 3420) you can make your own cables measuring up to 100m.

## IMPORTANT

When SYSTEM CABLE is used to supply power to another Dataton unit, the maximum length is 25m. In all other cases, up to 100m of SYSTEM CABLE can be used between units.



# EXTENSION CABLE

Art. No. 3451

1 m (40")

Art. No. 3452

2 m (80")

Art. No. 3455

5 m (200")

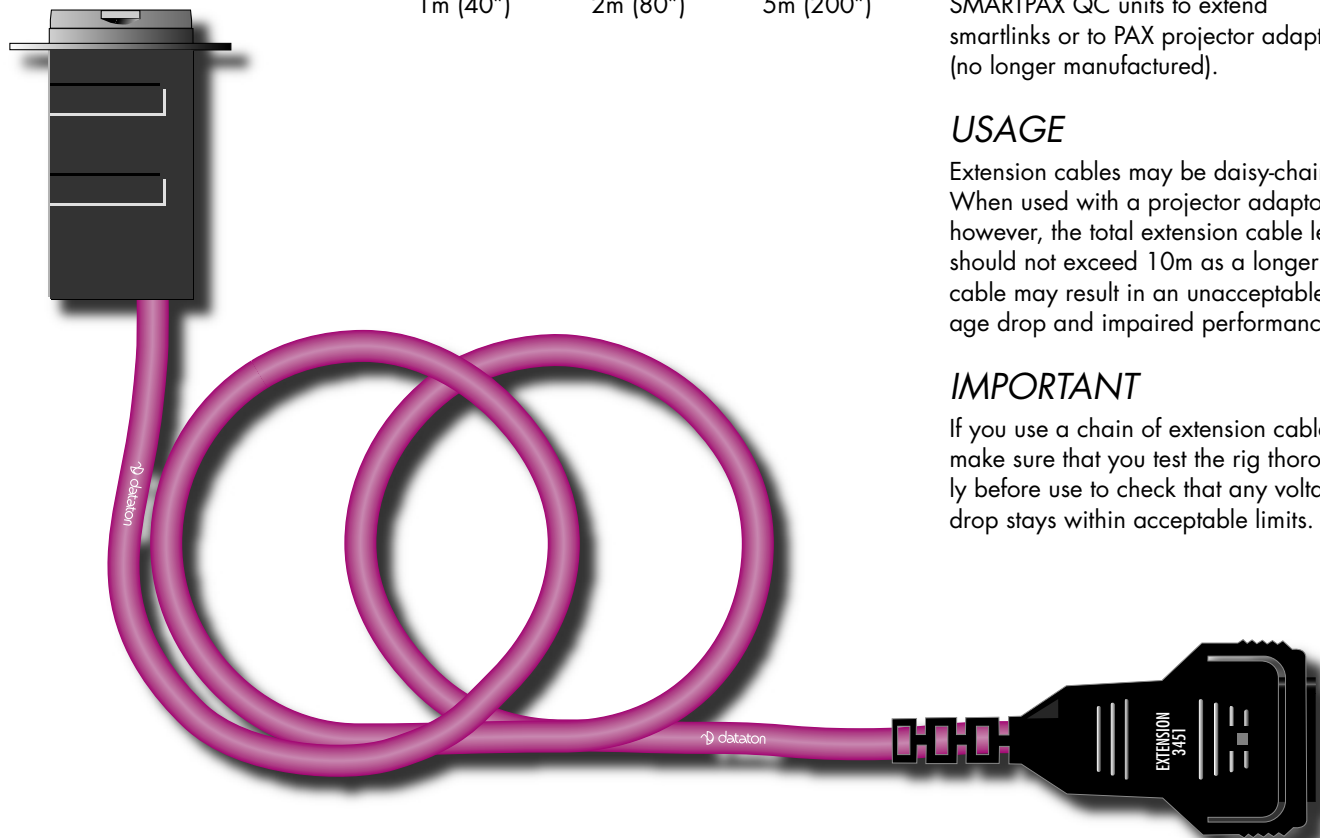

## GENERAL

EXTENSION CABLE is available in standard lengths of one, two and five meters. Extension cables connect to SMARTPAX QC units to extend smartlinks or to PAX projector adaptors (no longer manufactured).

## USAGE

Extension cables may be daisy-chained. When used with a projector adaptor, however, the total extension cable length should not exceed 10m as a longer cable may result in an unacceptable voltage drop and impaired performance.

## IMPORTANT

If you use a chain of extension cables make sure that you test the rig thoroughly before use to check that any voltage drop stays within acceptable limits.

# SYSTEM IN SMARTLINK

Art. No. 3477

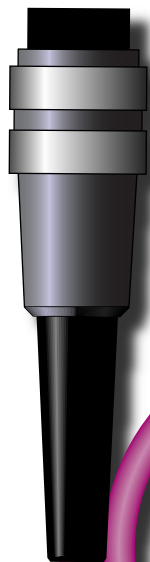

SYSTEM IN SMARTLINK is used to **INPUT** data from other Dataton control units to SMARTPAX QC. This function only works with Dataton TRAX version 3 or later.

The snap-lock connector plugs into one of the ports on the back of SMARTPAX; the male six pin plug goes to the DATA OUT connector on MICTOUCH, AIRLINK RECEIVER or TRANSPAX. For details on how to program applications using this smartlink, please refer to the device information database inside Dataton TRAX®.

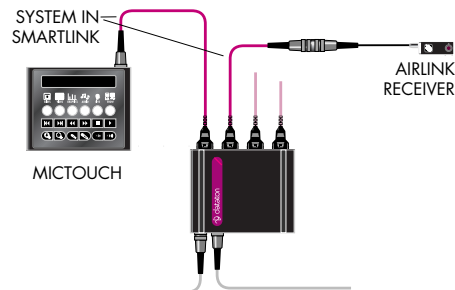

## Using SYSTEM IN SMARTLINK

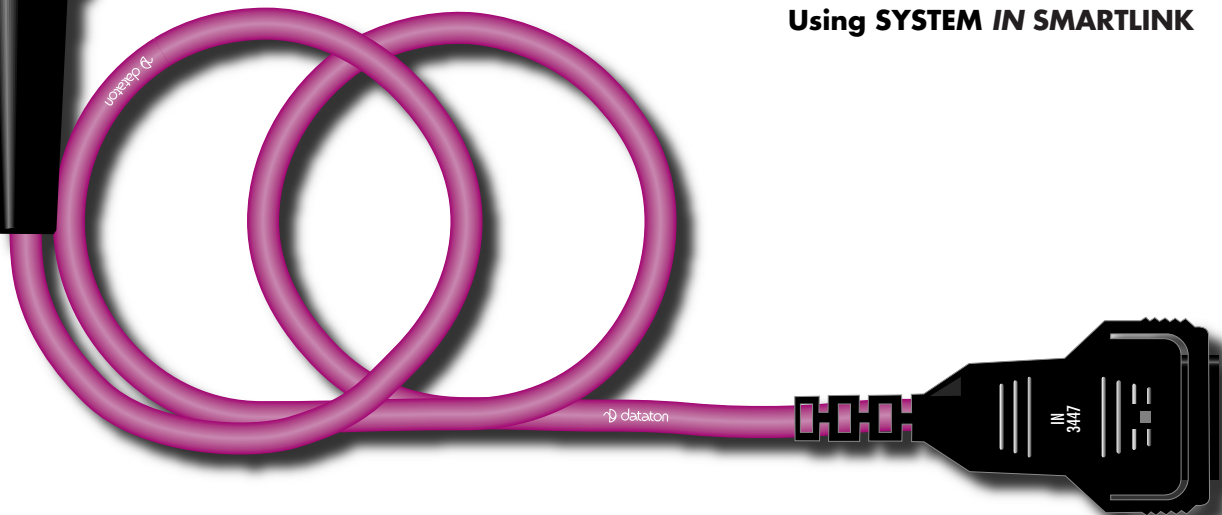

# SYSTEM OUT SMARTLINK

Art. No. 3478

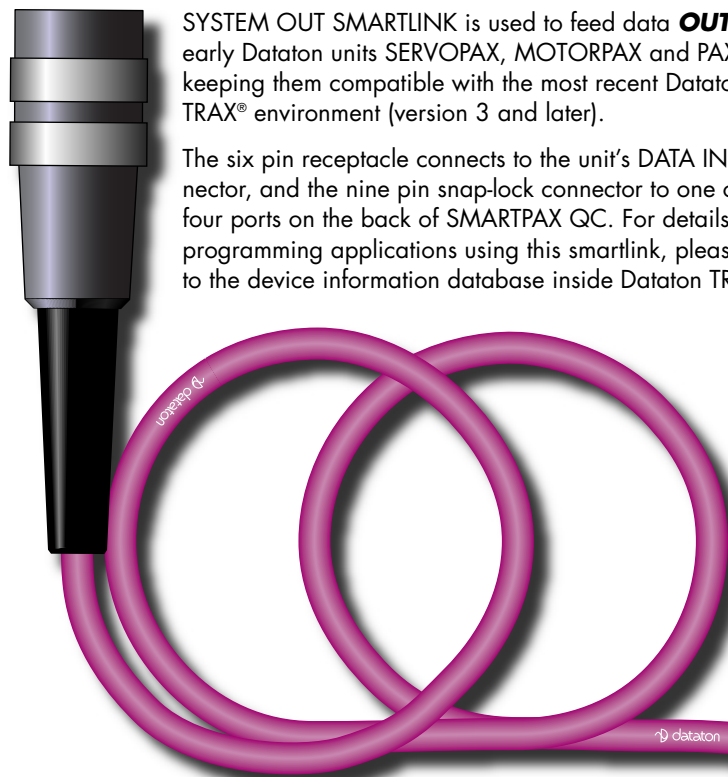

SYSTEM OUT SMARTLINK is used to feed data **OUT** to early Dataton units SERVOPAX, MOTORPAX and PAX, keeping them compatible with the most recent Dataton TRAX® environment (version 3 and later).

The six pin receptacle connects to the unit's DATA IN connector, and the nine pin snap-lock connector to one of the four ports on the back of SMARTPAX QC. For details on programming applications using this smartlink, please refer to the device information database inside Dataton TRAX.

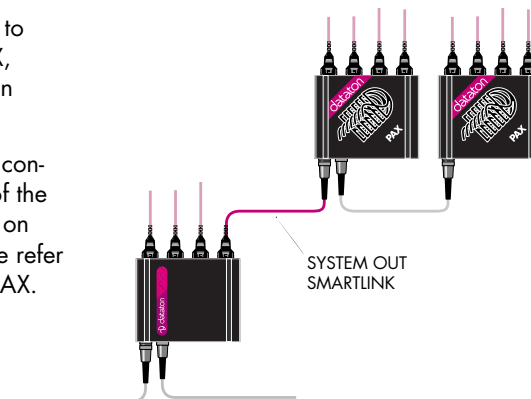

Using **SYSTEM OUT SMARTLINK**



CABLE COMING FROM 12V DC ADAPTOR 3334

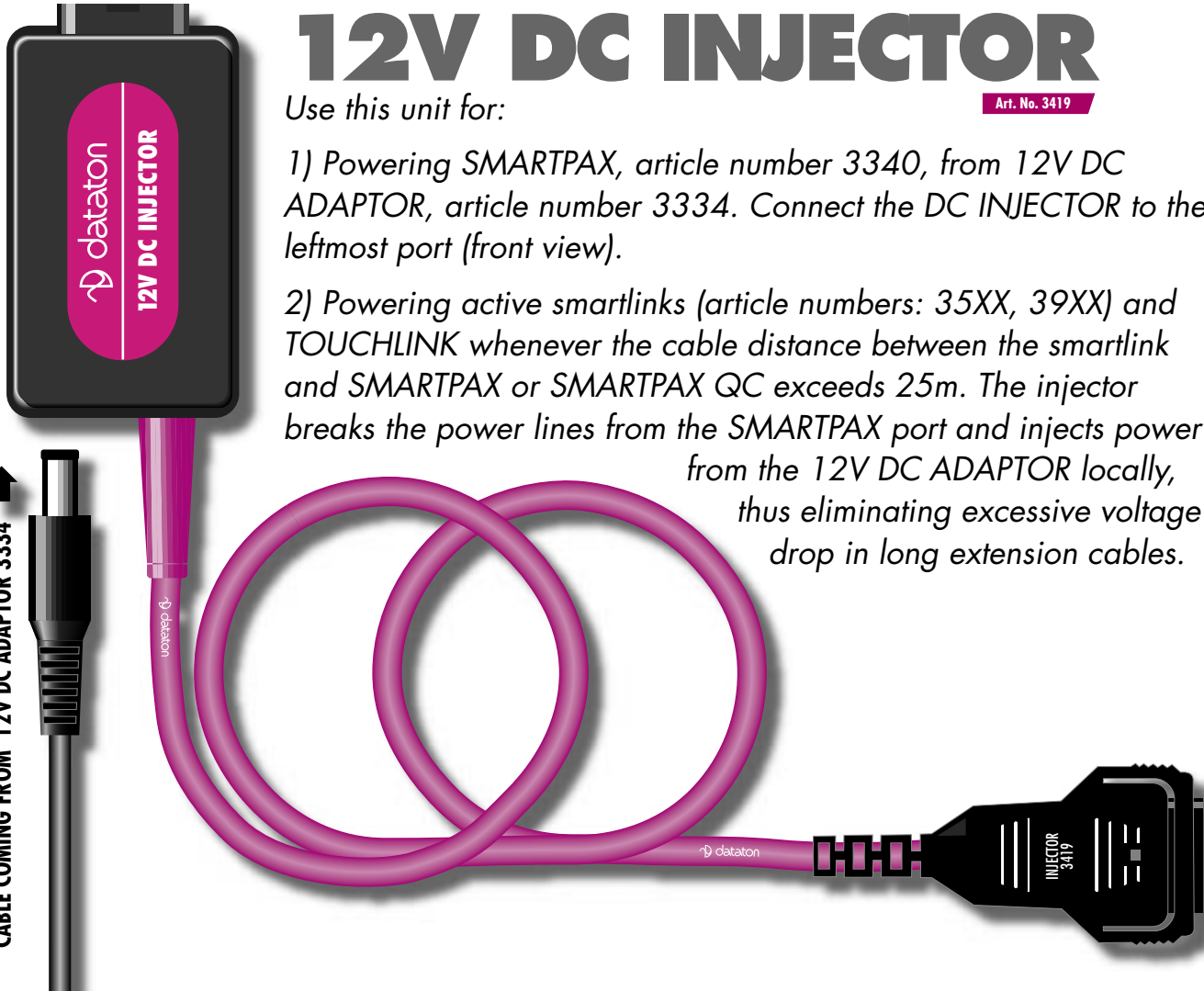

# 12V DC INJECTOR

Art. No. 3419

Use this unit for:

- 1) Powering SMARTPAX, article number 3340, from 12V DC ADAPTOR, article number 3334. Connect the DC INJECTOR to the leftmost port (front view).
- 2) Powering active smartlinks (article numbers: 35XX, 39XX) and TOUCHLINK whenever the cable distance between the smartlink and SMARTPAX or SMARTPAX QC exceeds 25m. The injector breaks the power lines from the SMARTPAX port and injects power from the 12V DC ADAPTOR locally, thus eliminating excessive voltage drop in long extension cables.

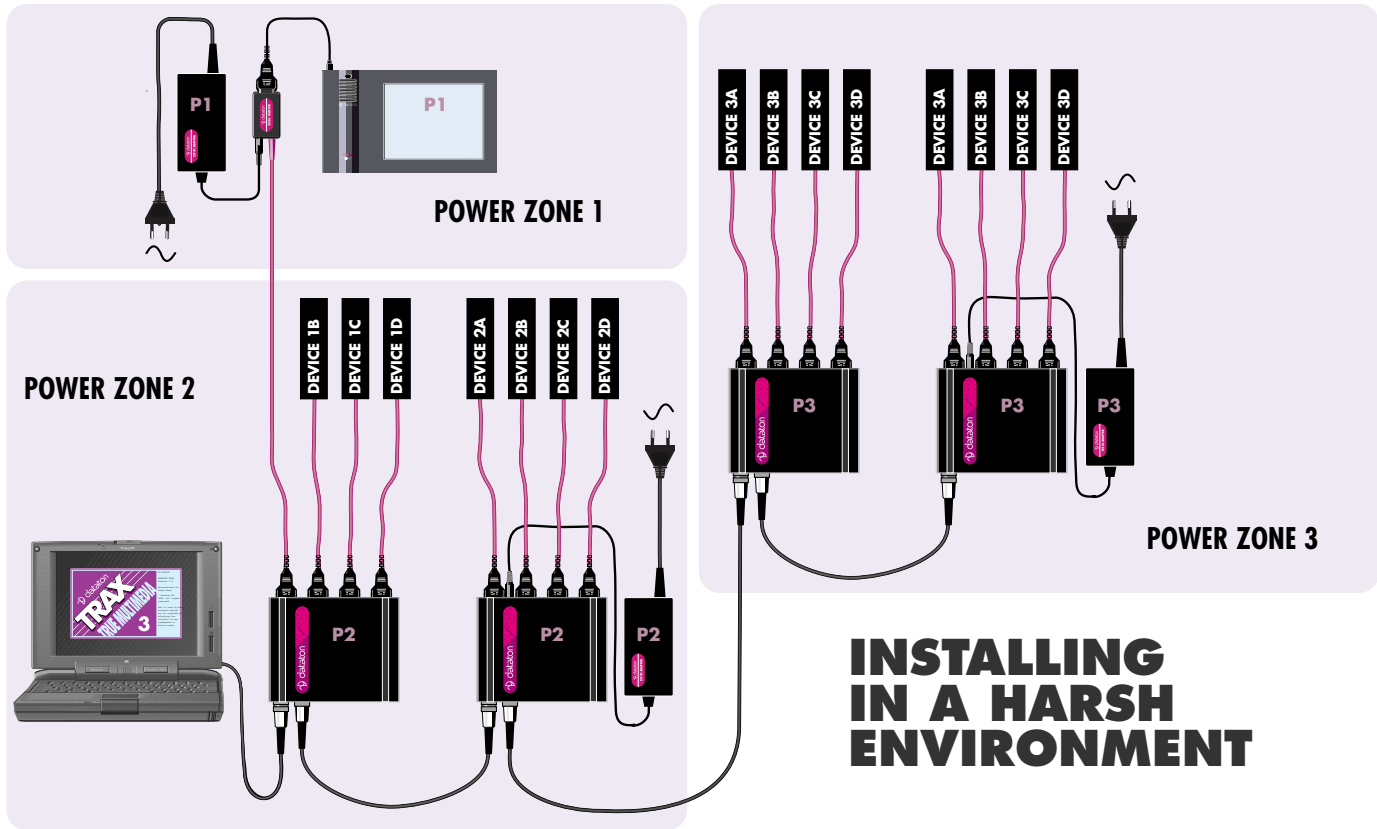

## INSTALLING IN A HARSH ENVIRONMENT

Dataton rigs very often have to operate in harsh environments, like exhibition halls, theaters, etc. To ensure reliable operation, it is important to adapt a well-engineered connection scheme. The

rig should be split into discrete power zones, where one zone of Dataton equipment is powered from one 12V DC ADAPTOR and other related devices from a common power outlet. Active

smartlink cables or TOUCHLINK units that are located away from the main rig, should receive power locally by means of 12V DC INJECTOR units, as indicated above for POWER ZONE 1.

# 12V DC ADAPTOR

Art. No. 3334



This unit is used to supply power to Dataton control units. It plugs directly into SMARTPAX QC; earlier Dataton units, such as SMARTPAX, PAX, TRANSPAX use the 12V DC INJECTOR, article number: 3419, to connect to this device.

## Technical Description

12V DC ADAPTOR is used to supply low voltage power to the entire Dataton control system.

*Size:* 45 × 89 × 23 mm  
1.75 × 35 × 0.92 "

*Weight:* 0.125 kg (5 ounces)

*Safety:* IEC 950, EN60950, UL1950 Class 2, SELV

*EMI:* UL, c-UL, VDE, NORDICS, MITI, EN55022 Class B, FCC Part 2 & 15 Class B, CISPR22 Class B

*MTBF:* >200 000 hours at full load and 25° C ambient conditions

## Input

*Input voltage:* 90-135, 170-264 VAC  
*Input current:* 0.8 A @ 100V maximum  
*Frequency:* 47 – 63 Hz

## Output

*Voltage:* 12V DC  
*Voltage regulation:* ±5%  
*Over voltage protection:* 16V maximum

*Current limit:* 3.0 A, ±5%

*Short circuit protection:* Pulsing mode, auto recovery

*Maximum power:* 35W

*Efficiency:* 90% nominal at full load and 230V AC

## Connectors



*Input:*  
IEC 320 input receptacle, two pin.



*Output:*  
EIAJ RC-5320, class IV.

0V on outer sleeve.

*Length of connecting cable:*  
1.6m (63")

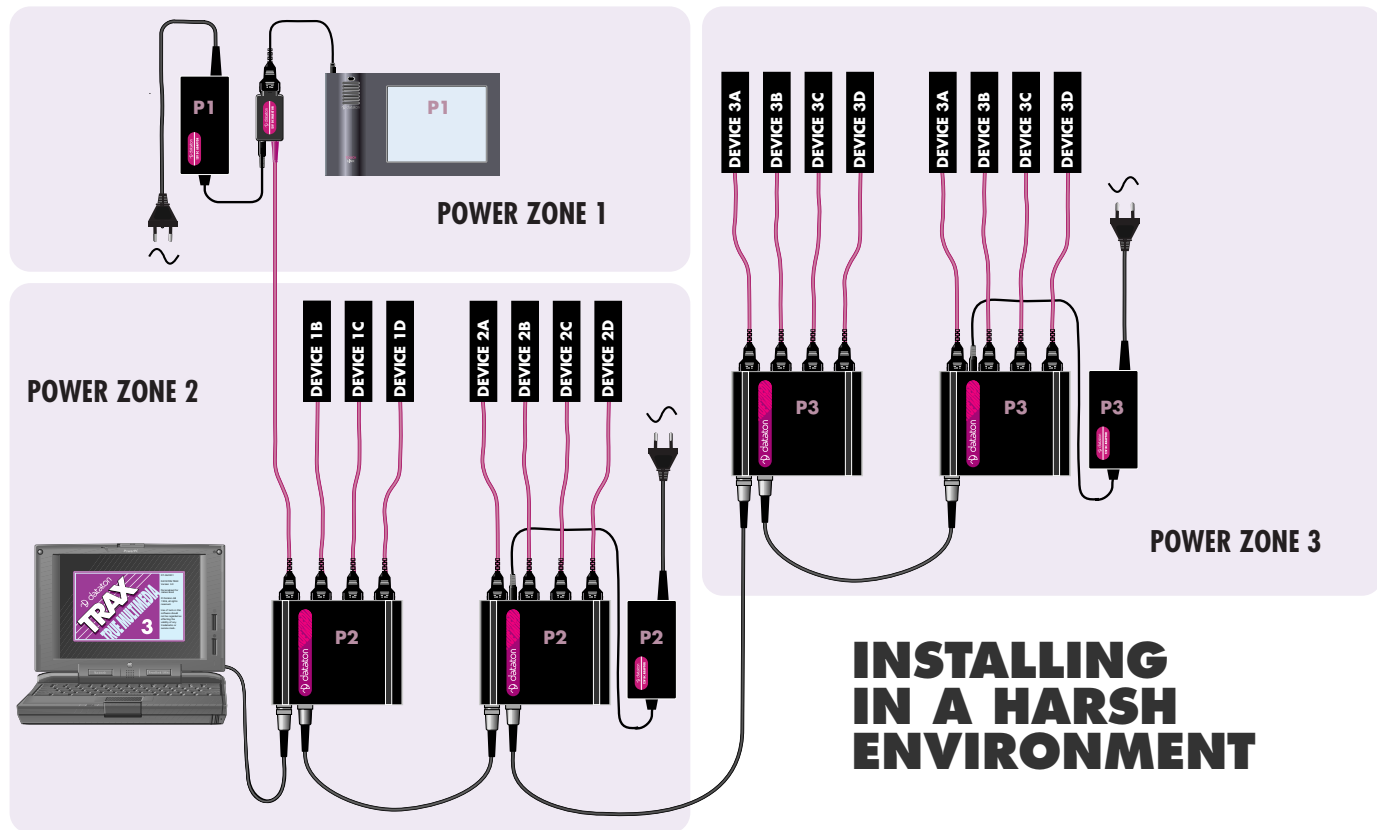

Dataton rigs very often have to operate in harsh environments, like exhibition halls, theaters, etc. To ensure reliable operation, it is important to adopt a well-engineered connection scheme. The

rig should be split into discrete power zones, where one zone of Dataton equipment is powered from one 12V DC ADAPTOR and other related devices from a common power outlet. Active

smartlink cables or TOUCHLINK units that are located away from the main rig, should receive power locally by means of 12V DC INJECTOR units, as indicated above for POWER ZONE 1.

# 24V AC BRIDGE

Art. No. 3442



Use the 24V AC BRIDGE cable to connect an external 24V AC power supply to Dataton SMARTPAX or other Dataton control units equipped with a 24V AC 2-pin connector.

To use your external 24V AC source, open the white terminal block and connect the cable from your source to the screw terminal.

*Power requirements:*

In order to ensure trouble free operation, use a high quality 24V output mains transformer, with a minimum VA rating of 20VA. As Dataton control devices do not contain any replaceable fuses, please ensure that your external 24V AC source contains a thermal overload fuse or a replaceable fuse. The supply voltage fed into any Dataton control device should, under no circumstances, exceed 27V AC.

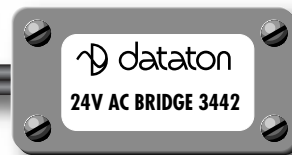

← **CONNECT  
YOUR 24V  
SOURCE HERE!**

# ONE U RACK MOUNT

Art. No. 3541

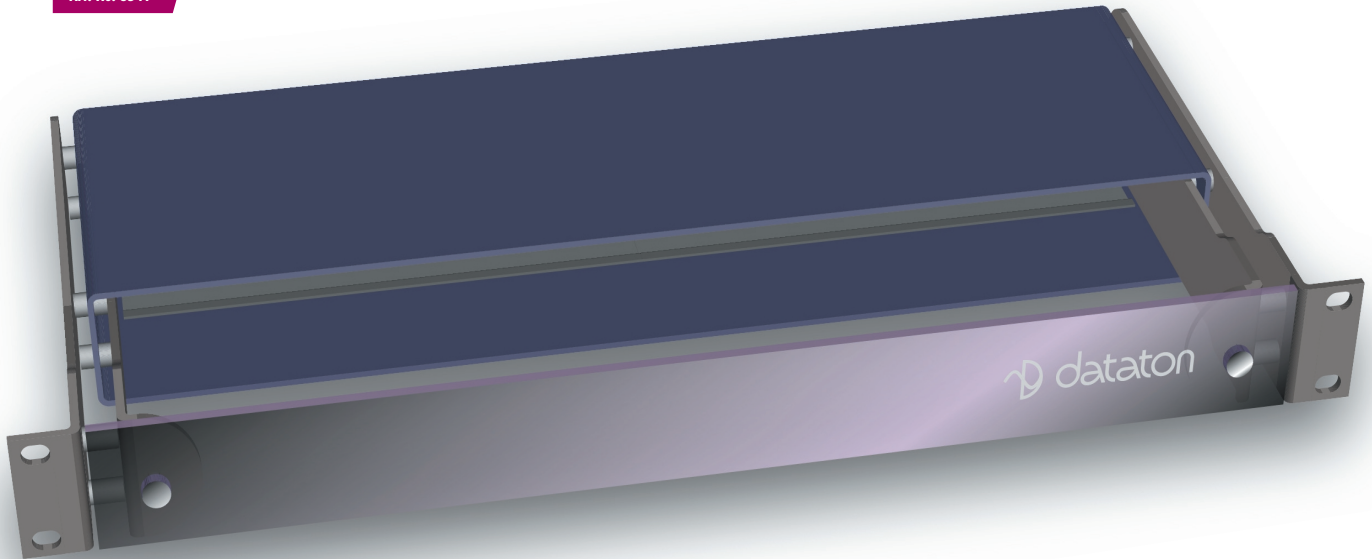

*The Dataton rack mount puts the finishing touch to your show installation. The rack mount is one unit high with a built-in DIN rail. It handles several different constellations of Dataton units for utmost flexibility in the field.*

*The rack mount is delivered fully assembled; simply slot your Dataton units into place and screw the mount into a 19 inch rack. The smoked glass front protects and conceals units while revealing indicator lights.*

## GENERAL

Use the ONE U RACK MOUNT to install Dataton units in a standard 19 inch rack.

The mount handles two SMARTPAX QC-sized units, plus power supply. It is also ideal for use with KEYLINK units. Four KEYLINK units, one SMARTPAX QC and one 12V DC ADAPTOR fit perfectly into the rack mount.

The ONE U RACK MOUNT is delivered pre-assembled. The top cover and base are removed with a torx. Use the enclosed nuts and original screws to conceal the holes left by the three posts.

The smoked glass front lets the user see the indicator lights on the Dataton units, while protecting the units from any casual prodding.

Running along the base plate is a 35 mm DIN rail to facilitate installation.

## USAGE

Remove the smoked glass front (if attached) before inserting your Dataton units in the ONE U RACK MOUNT.

*You may also need to remove the top cover and posts, eg, if you want to insert a 12V DC ADAPTOR as shown in the illustrations.*

KEYLINK units are mounted with the keys towards the back; other Dataton units are mounted with the control dials facing forwards.

Line up the units with the clips in the rack.

To insert a unit: gently, but firmly, push it backward at a slight downward angle. Push until the clips grip the edge of the unit, thereby holding it in place.

To remove a unit from the rack mount: push the unit backward until the front clips release their hold. Depress the sprung clips and pull the unit out.

Connect power and control cables.

Slot the ONE U RACK MOUNT into a 19 inch rack and secure it.

When you are satisfied that the installed units are working correctly, screw the smoked glass front into place.



*Top: Rack mount with two SMARTPAX QC and a 12V DC ADAPTOR.*

*Bottom: SMARTPAX QC, 12V DC ADAPTOR, and four KEYLINK units.*

*Similar sized units, such as POWERLINK, also fit into the rack mount.*

# KRAMER SMARTLINK

Art. No. 3489

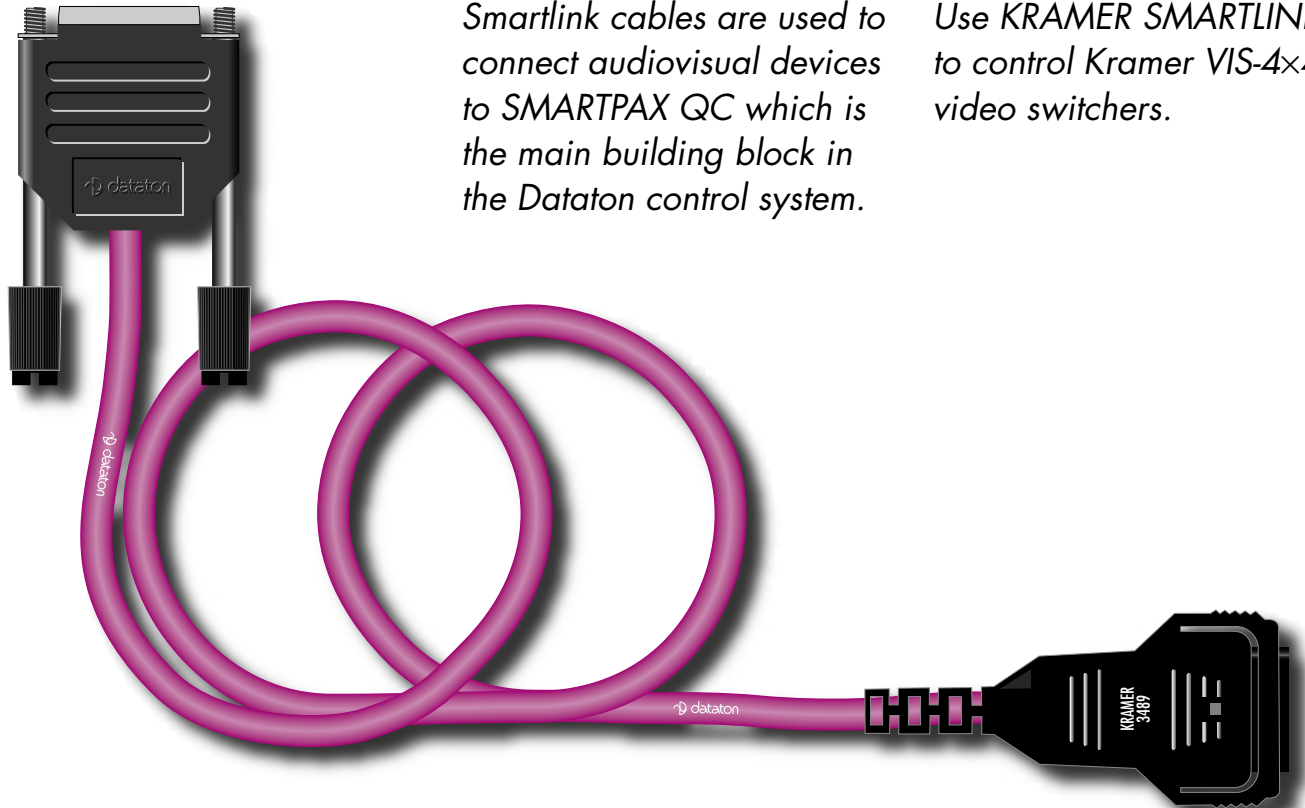

*Smartlink cables are used to connect audiovisual devices to SMARTPAX QC which is the main building block in the Dataton control system.*

*Use KRAMER SMARTLINK to control Kramer VIS-4x4 video switchers.*



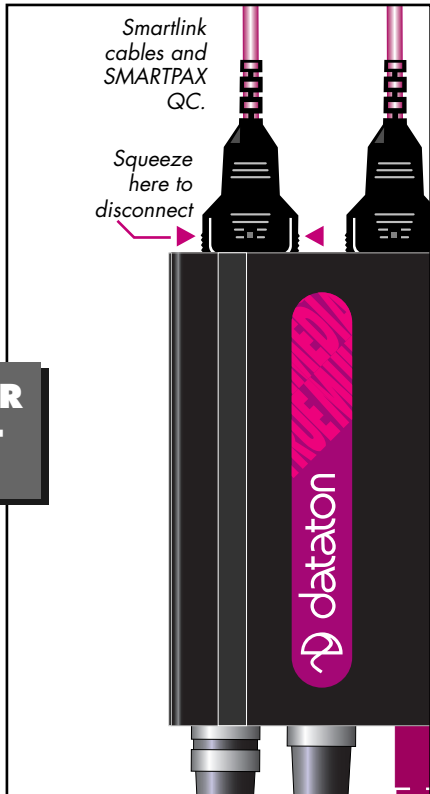

**IMPORTANT**

Always connect the smartlink to the switcher and SMARTPAX QC before turning on the power.

**USAGE**

The Kramer VIS-4x4 is a matrix switcher for composite video and audio. It has four inputs and four outputs, and a built-in distribution amplifier.

You will find the latest information on using this device in the device information database in Dataton TRAX. The SMARTPAX QC product sheet and the TRAX handbook contain general info on SMARTPAX, TRAX and smartlinks.

**PROGRAMMING**

The Kramer switcher is listed as a Serial device in Dataton TRAX. To program it, select a Trigger cue from the Cue menu. Under "Device Specific Mode" in this cue you may then view the functions that are supported.

The Kramer switcher has an internal and external array of dip switches. The internal array is mounted on the RS232 card. Set the dip switches as below:

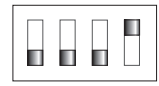

Internal array

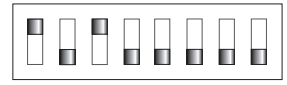

External array

**Technical Description**

The KRAMER SMARTLINK cable length is 1.6m (63") and may be extended with Dataton EXTENSION CABLE, article number 3451 (1m), 3452 (2m) or 3455 (5m).

Pin number at SMARTPAX end	Color code	Signal symbol	Pin number on D-sub 9-pin male
1	Brown	DTR	4
2	Red	TxD	3
3	Orange	Gnd	5
4	Yellow	RxD	2
5	(Green)		
6	(Blue)		
7	(Violet)		
8	Grey	Gnd	5
9	(Black)	Screen	5
			6
			8